

Digital Timer H5CX-□-N

Ultra-compact Timer Provides Advanced Functions and Security Settings.



Basic Features

- Short body with depth of only 59 mm (for 24-VAC / 12 to 24-VDC Models with Screw Terminals). *1
- Character height of 12 mm for better readability (on models with 4 digits).
- The present value display characters can be switched between red, green, and orange. *2

Safety and Reliability

- Power supply circuit and input circuits are isolated for safety and reliability. *3
- New set value limit and output counter functions have been added. *4

Other Features

- Front Panel can be changed to white or light gray. *5
- Models with instantaneous contact output added to the series.

- *1. For 100 to 240 VAC Models with Screw Terminals 78 mm, Models with Sockets: 63.7 mm (case dimension).
- *2. The H5CX-A11, H5CX-L8 and H5CX-B Timers have only red characters.
- *3. Specifications: 100 to 240 VAC
- *4. The value of the output counter can only be monitored. It cannot be reset.
- *5. Replacement Front Panels sold separately.



For the most recent information on models that have been certified for safety standards, refer to your OMRON website.

Refer to "Safety Precautions" on page 41.

Features

Basic Features

Ultra Short Body

The body depth has been greatly reduced. Helps in making thinner control panels. (Models with Screw Terminals)

24-VAC / 12 to 24-VDC Models with Screw Terminals: 59 mm
100 to 240-VAC / VDC Models with Screw Terminals: 78 mm *
Models with Sockets: 63.7 mm (case dimension)

* The shortest body for a timer with isolated power supply and input circuits and a maximum ambient temperature of 55°C (according to OMRON investigation in June 2009).

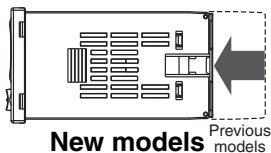

Easier to Read

For better readability, the character height for the present value display is 12 mm (on models with 4 digits), the largest class in the industry. The wide viewing angle and brightness provide excellent visibility. The number of display segments has also been increased to make settings easier to understand, and the present value display can be switched between red, green and orange so that output status can be seen from a distance.

Model with 4 Digits Model with 6 Digits



down (Display example)

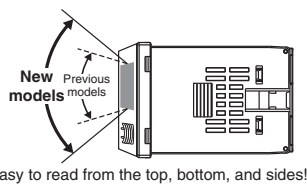

Note: The H5CX-A11 and H5CX-L8 Timers have only red characters.

The Easiest Operation

Operation is simplified by the Up/Down Keys for each digit on 4-digit models and Up Keys for each digit on 6-digit models.

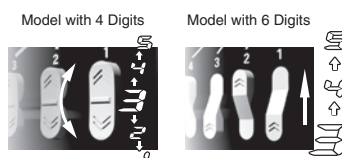

Safety and Reliability

Isolated Power Supply and Input Circuits *1

Power supply circuit and input circuits are isolated for safety and reliability.

Previous non-isolated timers had wiring restrictions and could be damaged if wired incorrectly. The New H5CX removes these worries.

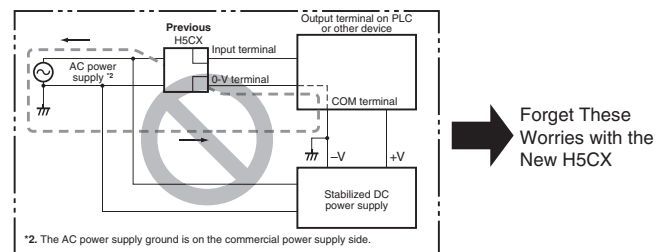

*2. The AC power supply ground is on the commercial power supply side.

Forget These Worries with the New H5CX

*1. New Models (H5CX-□-N) with 100 to 240-VAC specifications.

Set Value Limit

You can set an upper limit for the set value to prevent unexpected operation of output devices caused by setting mistakes.



Output Counter

An output counter counts the number of times that the output turns ON. (An alarm can be set and the value of the output counter can be monitored, Unit: 1,000 operations.) This counter is useful in managing the service life of the Timer or the load.

Other Features

Change the Front Panel Color

The Front Panel can be replaced with an optional Front Panel (order separately) with a different color to match the installation site. Select from black, white, and light gray.

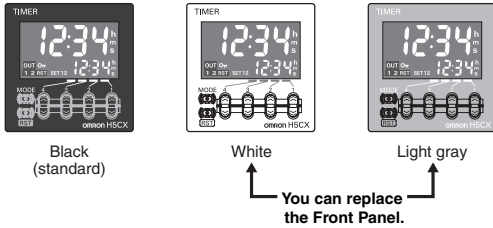

Models with Instantaneous Contact Output

Models with instantaneous contact outputs have been added to the lineup for use with self-holding circuits and as auxiliary relays. These models are also convenient when replacing analog timers.

Universal NPN/PNP Input

DC 2-wire sensors can be connected for a wide range of input devices.

Waterproof, Dust-proof Structure (UL508 Type 4X and IP66)

Worry-free application is possible in locations subject to water.
Note: When the Y92S-29 Waterproof Packing is used.

Key Protection

Select from any of seven protection patterns. Use the best one for the application.

New Modes

Modes, such as a stopwatch mode (Mode S), have been added.
 Select any of 15 modes.

Model Number Structure

Model Configuration

		H5CX Series				
		Standard Type H5CX-A Series		Economy Type H5CX-L Series		Six-digit Type
Type						
Model		H5CX-A□-N	H5CX-A11□-N	H5CX-L8□-N	H5CX-L8E□-N	H5CX-BWSD-N
Function	Timer	Yes		Yes		No
	Twin timer	Yes		Yes		No
	Two-stage settings/ forecast output	No		No		Yes
Operating modes	Timer Mode: 11 modes Twin Timer Mode: 4 modes			Timer Mode : 4 modes Twin Timer Mode : 2 modes	Timer Mode: 2 modes	
Input	NPN/PNP input		NPN input	None		NPN/PNP input
External connections	Screw terminal block	11-pin socket		8-pin socket		Screw terminal block
Present value display character color	Red, green, or orange	Red				
Number of display digits	4					6
Instantaneous contacts	None			Provided		None
Gate input	Supported		Not supported			Supported
DIP switch settings	Provided		None			Provided
Power supply voltage	100 to 240 VAC or 24 VAC/12 to 24 VDC					12 to 24 VDC

Model Number Legend (Not all possible combinations of functions are available.)

H5CX-□□□□□-N

1 2 3 4 5

1. Type Classifier

Symbol	Meaning
A	Standard type
B	6-digit type
L	Economy type

4. Output type

Symbol	Meaning
None	Contact output (time-limit SPDT)
E	Contact output (time-limit SPDT + instantaneous SPDT) *
S	Transistor output

* Can be used as a time-limit DPDT output.

2. External Connections

Symbol	Meaning
None	Screw terminals
8	8-pin socket
11	11-pin socket

5. Supply voltage

Symbol	Meaning
None	100 to 240 VAC 50/60 Hz
D	12 to 24 VDC/24 VAC 50/60 Hz *

* The H5CX-BWSD-N is available only for 12 to 24 VDC.

3. Settings

Symbol	Meaning
None	One stage
W	Two stages

Note: Estimates can be provided for coatings and other specifications that are not given in the datasheet. Ask your OMRON representative for details.

Ordering Information

List of Models

Type	Time specifications	Operating modes	External connections	Inputs	Outputs	Supply voltage	Models
H5CX-A	0.001 to 9.999 s 0.01 to 99.99 s 0.1 to 999.9 s 1 to 9999 s 1 s to 99 min 59 s 0.1 to 999.9 min 1 to 9999 min 1 min to 99 h 59 min 0.1 to 999.9 h 1 to 9999 h	Timer Mode A: Signal ON Delay I A-1: Signal ON Delay II A-2: Power ON Delay I A-3: Power ON Delay II b: Repeat cycle 1 b-1: Repeat cycle 2 d: Signal OFF Delay E: Interval F: Cumulative Z: ON/OFF-duty-adjustable flicker S: Stopwatch	Screw terminals	Signal, Reset, Gate (NPN/PNP inputs)	Contact output (time-limit SPDT)	100 to 240 VAC	H5CX-A-N
					Transistor output (SPST)	12 to 24 VDC/24 VAC	H5CX-AD-N
						100 to 240 VAC	H5CX-AS-N
			11-pin socket		Contact output (time-limit SPDT)	12 to 24 VDC/24 VAC	H5CX-ASD-N
					Transistor output (SPST)	100 to 240 VAC	H5CX-A11-N
						12 to 24 VDC/24 VAC	H5CX-A11D-N
H5CX-L	1 s to 99 min 59 s 0.1 to 999.9 min 1 to 9999 min 1 min to 99 h 59 min 0.1 to 999.9 h 1 to 9999 h	Twin Timer Mode toff: Flicker OFF Start 1 ton: Flicker ON Start 1 toff-1: Flicker OFF Start 2 ton-1: Flicker ON Start 2	8-pin socket	Signal, Reset (NPN inputs)	Contact output (time-limit SPDT)	100 to 240 VAC	H5CX-A11S-N
					Transistor output (SPST)	12 to 24 VDC/24 VAC	H5CX-A11SD-N
						100 to 240 VAC	H5CX-L8-N
			None		Contact output (time-limit SPDT + instantaneous SPDT) Models with instantaneous contact outputs	12 to 24 VDC/24 VAC	H5CX-L8D-N
						100 to 240 VAC	H5CX-L8S-N
						12 to 24 VDC/24 VAC	H5CX-L8SD-N
H5CX-L	100 to 240 VAC	H5CX-L8E-N					
		12 to 24 VDC/24 VAC	H5CX-L8ED-N				
H5CX-B	0.01 to 9999.99 s 1 s to 99 h 59 min 59 s 0.1 to 99999.9 min 0.1 to 99999.9 h	A: Signal ON Delay I F-1: Cumulative	Screw terminals	Signal, Reset, Gate (NPN/PNP inputs)	Transistor output (DPST)	12 to 24 VDC	H5CX-L8-N

Note: 1. The functions that are provided depend on the model. Check detailed specifications before ordering.

2. Refer to **page 33** and later for information on H5CX-B Timers (6-digit display).

Accessories (Order Separately)

Front Panels (Replacement Parts)

Models	Color	Applicable Timers	Page
Y92P-CXT4G	Light gray (5Y7/1)	Four-digit models	12
Y92P-CXT4S	White (5Y9.2 / 0.5)		
Y92P-CXT4B	Black (N1.5)		

Note: 1. You can change the color of the front panel when mounting the Timer. The Timer is shipped with a black (N1.5) Front Panel.
 2. "TIMER" is printed on the front of Replacement Front Panels.

Soft Cover

Models	Remarks	Page
Y92A-48F1	---	12

Hard Cover

Models	Remarks	Page
Y92A-48	---	12

Flush Mounting Adapter

Models	Remarks	Page
Y92F-30	Included with models with terminal blocks.	12
Y92F-45	Use this Adapter to install the Timer in a cutout previously made for a DIN 72 x 72 mm device (panel cutout: 68 x 68 mm).	

Waterproof Packing

Models	Remarks	Page
Y92S-29	Included with models with terminal blocks.	12

Connection Sockets

Models	Type	Connectable Timers	Remarks	Page
P2CF-08	Front Connecting Socket	H5CX-L8□	Round crimp terminals cannot be used on Finger-safe Sockets. Use forked crimp terminals.	13
P2CF-08-E	Front Connecting Socket (Finger-safe Type)			
P2CF-11	Front Connecting Socket	H5CX-A11□	Round crimp terminals cannot be used on Finger-safe Sockets. Use forked crimp terminals.	
P2CF-11-E	Front Connecting Socket (Finger-safe Type)			
P3G-08	Back Connecting Socket	H5CX-L8□	A Y92A-48G Terminal Cover can be used with the Socket to create a finger-safe construction.	
P3GA-11		H5CX-A11□		

Terminal Covers for P3G-08 and P3GA-11 Back-connecting Sockets

Models	Remarks	Page
Y92A-48G	---	14



H5CX-A□-N/-L□-N Digital Timers

- Switch the display color* between red, green, and orange to see the output status from a distance.
- Up/Down Keys for each digit enable easy operation.
- Cyclic control is easy with the Twin Timer and Variable ON/OFF Duty modes.

* Not supported by the H5CX-A11□ or H5CX-L8□.



For the most recent information on models that have been certified for safety standards, refer to your OMRON website.

Specifications

Ratings

Item	Models	H5CX-A□-N	H5CX-A11□-N	H5CX-L8□-N
Classification		Standard Type		Economy Type
Ratings	Power supply voltage *1	<ul style="list-style-type: none"> • 100 to 240 VAC 50/60 Hz • 12 to 24 VDC/24 VAC 50/60 Hz 		
	Operating voltage fluctuation range	85% to 110% of rated supply voltage (90% to 110% at 12 to 24 VDC)		
	Power consumption	Approx. 6.2 VA at 100 to 240 VAC, Approx. 5.1 VA/2.4 W at 24 VAC/12 to 24 VDC *2		
Mounting method		Flush mounting	Flush mounting, surface mounting, DIN track mounting	
External connections		Screw terminals	11-pin socket	8-pin socket
Degree of protection		IEC IP66, UL508 Type 4X (indoors) for panel surface only and when Y92S-29 Waterproof Packing is used		
Digits		4 digits		
Time ranges		0.001 s to 9.999 s, 0.01 s to 99.99 s, 0.1 s to 999.9 s, 1 s to 9999 s, 1 s ti 99 min 59 s 0.1 m to 999.9 min, 1 min to 9999 min, 1 min to 99 h 59 min, 0.1 h to 999.9 h, 1 h to 9999 h		
Timer mode		Elapsed time (Up), remaining time (Down) (selectable)		
Inputs	Input signals	Signal, Reset, Gate		Signal, Reset (no inputs on models with instantaneous contact outputs)
	Input method	No-voltage Input ON impedance: 1 kΩ max. (Leakage current: 12 mA when 0 Ω) ON residual voltage: 3 V max. OFF impedance: 100 kΩ min. Voltage Input High (logic) level: 4.5 to 30 VDC Low (logic) level: 0 to 2 VDC (Input resistance: approx. 4.7 kΩ) No-voltage input/voltage input (switchable)		No-voltage Input ON impedance: 1 kΩ max. (Leakage current: 12 mA when 0 Ω) ON residual voltage: 3 V max. OFF impedance: 100 kΩ min.
	Signal, reset, gate	Minimum input signal width: 1 or 20 ms (selectable, same for all input)		
Reset system		Power reset (depending on output mode), external reset, manual reset, automatic reset (depending on output mode)		
Power reset		Minimum power-opening time: 0.5 s (except for A-3, b-1, F, ton-1, and toff-1 mode)		
Reset voltage		10% max. of rated supply voltage		
Sensor waiting time		250 ms max. (Control output is turned OFF and no input is accepted during sensor waiting time.)		
Output	Output modes	A: Signal ON Delay I, A-1: Signal ON Delay II, A-2: Power ON Delay I, A-3: Power ON Delay II, b: Repeat Cycle 1, b-1: Repeat Cycle 2, d: Signal OFF Delay, E: Interval, F: Cumulative, Z: ON/OFF-duty-adjustable flicker, S: Stopwatch, toff: Flicker OFF Start 1, ton: Flicker ON Start 1, toff-1: Flicker OFF Start 2, ton-1: Flicker ON Start 2		Models with Instantaneous Contact Outputs A-2: Power ON Delay I, b: Repeat Cycle 1, E: Interval, Z: ON/OFF-duty-adjustable flicker, toff: Flicker OFF Start 1, ton: Flicker ON Start 1
	One-shot output time	0.01 to 99.99 s		
	Control output	<ul style="list-style-type: none"> • Models with Contact Outputs 5 A at 250 VAC/30 VDC, resistive load (cos = 1) Minimum applied load: 10 mA at 5 VDC (failure level: P, reference value) Contact materials : AgSnIn • Transistor output: NPN open collector, 100 mA at 30 VDC max., residual voltage: 1.5 VDC max. (Approx. 1 V), Leakage current: 0.1 mA max. 		
Display method *3		7-segment, negative transmissive LCD; Present value: 12-mm-high characters, (switchable between red, green, and orange) Set value: 6-mm-high characters, green	7-segment, negative transmissive LCD; Present value: 12-mm-high characters, red Set value: 6-mm-high characters, green	
Memory backup		EEPROM (overwrites: 100,000 times min.) that can store data for 10 years min.		
Operating temperature range		-10 to 55°C (-10 to 50°C if counters are mounted side by side) (with no icing or condensation)		
Storage temperature range		-25 to 70°C (with no icing or condensation)		
Operating humidity range		25% to 85%		
Case color		Black (N1.5) (Optional Front Panels are available to change the Front Panel color to light gray or white.)		
Attachments		Waterproof packing, flush mounting adapter, label for DIP switch settings	Label for DIP switch settings	---

*1. Do not use the output from an inverter as the power supply. The ripple must be 20% maximum for DC power.

*2. Inrush current will flow for a short time when the power supply is turned ON.
Inrush Current (Reference Values)

Voltage	Applied voltage	Inrush current (peak value)	Time
100 to 240 VAC	264 VAC	5.3 A	0.4 ms
	26.4 VAC	6.4 A	1.4 ms
12 to 24 VDC/24 VAC	26.4 VDC	4.4 A	1.7 ms

*3. The display is lit only when the power is ON. Nothing is displayed when power is OFF.

Characteristics

Accuracy of operating time and setting error (including temperature and voltage influences)	Power-ON start: $\pm 0.01\% \pm 50$ ms max. (See note 1.) Signal start: $\pm 0.005\% \pm 30$ ms max. (See note 1.) Signal start for transistor output model: $\pm 0.005\% \pm 3$ ms max. (See note 1 and 2.) If the set value is within the sensor waiting time at startup the control output of the H5CX will not turn ON until the sensor waiting time passes. Note: 1. The values are based on the set value. 2. The value is applied for a minimum pulse width of 1 ms.	
Insulation resistance	100 M Ω min. (at 500 VDC) between current-carrying terminal and exposed non-current-carrying metal parts, and between non-continuous contacts	
Dielectric strength	2,000 VAC, 50/60 Hz for 1 min between current-carrying metal parts and non-current-carrying metal parts 2,000 VAC, 50/60 Hz for 1 min between power supply and input circuits for the models other than H5CX-□D-N 1,000 VAC, 50/60 Hz for 1 min between control output, power supply, and input circuits for H5CX-□SD-N 2,000 VAC, 50/60 Hz for 1 min between control output, power supply, and input circuits for other models 1,000 VAC, 50/60 Hz for 1 min between non-continuous contacts	
Impulse withstand voltage	5 kV (between power terminals) for 100 to 240 VAC, 1 kV for 24 VAC/12 to 24 VDC 5 kV (between current-carrying terminal and exposed non-current-carrying metal parts) for 100 to 240 VAC 1.5 kV for 24 VAC/12 to 24 VDC	
Noise immunity	± 1.5 kV (between power terminals) and ± 600 V (between input terminals), square-wave noise by noise simulator (pulse width: 100 ns/1 μ s, 1-ns rise)	
Static immunity	Malfunction: 8 kV Destruction: 15 kV	
Vibration resistance	Destruction	10 to 55 Hz with 0.75-mm single amplitude each in three directions for 2 h each
	Malfunction	10 to 55 Hz with 0.35-mm single amplitude each in three directions for 10 min each
Shock resistance	Destruction	300 m/s ² in three directions, three cycles
	Malfunction	100 m/s ² in three directions, three cycles
Life expectancy	Mechanical	10,000,000 operations min. (under no load at 1,800 operations/h and ambient temperature of 23°C)
	Electrical	100,000 operations min. (5 A at 250 VAC, resistive load at 1,800 operations/h and ambient temperature of 23°C) *
Weight	Approx. 115 g (Timer only)	

* Refer to Life-test Curve.

Life-test Curve (Reference Values)

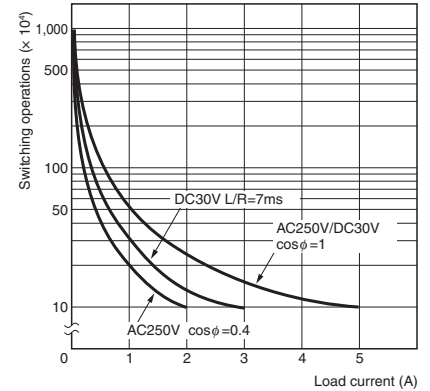

A maximum current of 0.15 A can be switched at 125 VDC (cosφ = 1) and a maximum current of 0.1 A can be switched if L/R is 7 ms. In both cases, a life of 100,000 operations can be expected.

Applicable Standards

Approved safety standards	UL508/Listing, UL508 Type 4X for indoor use (enclosure rating), CSA C22.2 No. 14 *1 , conforms to EN61812-1 (Pollution degree 2/overvoltage category III) B300 PILOT DUTY 1/4 HP 120 VAC, 1/3 HP, 240 VAC, 5 A resistive load VDE0106/P100 CCC: GB/T 14048.5 Pollution degree 2, Overvoltage category III *2,*3
EMC	(EMI) Emission Enclosure: EN61812-1 EN55011 Group 1 class A Emission AC mains: EN55011 Group 1 class A (EMS) Immunity ESD: EN61812-1 IEC61000-4-2 Immunity RF-interference: IEC61000-4-3 Immunity Burst: IEC61000-4-4 Immunity Surge: IEC61000-4-5 Immunity Conducted Disturbance: IEC61000-4-6 Immunity Voltage Dip/Interruption: IEC61000-4-11

***1.** The following safety standards apply to models with sockets (H5CX-A11□ or H5CX-L8□).

cUL (Listing): Applicable when an OMRON P2CF (-E) Socket is used.

cUR (Recognition): Applicable when any other socket is used.

***2.** Excluding the H5CX-ASD-N/-A11SD-N/-L8SD-N.

***3.** CCC certification requirements

Rated operating voltage Ue Rated operating current Ie	Contact Output: AC-15: Ue: 250 VAC, Ie: 3 A AC-13: Ue: 250 VAC, Ie: 5 A DC-13: Ue: 30 VDC, Ie: 0.5 A Transistor Output: DC-13: Ue: 30 VDC, Ie: 0.1 A
Rated insulation voltage	250 V
Rated impulse withstand voltage (altitude: 2,000 m max.)	4 kV (at 240 VAC)
Conditional short-circuit current	1000 A

I/O Functions

For details, refer to the timing charts on **page 20 and page 29**.

Inputs *1	Start signal	Normally functions to start timing. In modes A-2 and A-3, disable timing. In mode S, starts and stops timing.
	Reset	<ul style="list-style-type: none"> Resets present value. (In elapsed time mode, the present value returns to 0; in remaining time mode, the present value returns to the set value.) Count inputs are not accepted and control output turns OFF while reset input is ON. Reset indicator is lit while reset input is ON.
	Gate *2	Disables timing. (If a reset occurs while the gate input is ON, a reset will be performed.)
Outputs	Control output (OUT)	Outputs take place according to designated operating mode when timer reaches corresponding set value.

***1.** The H5CX-L8E□ does not have an input.

***2.** The H5CX-L□ does not have a gate input.

Response Delay Time When Resetting (Transistor Output)

The following table shows the delay from when the reset signal is input until the output is turned OFF.

(Reference value)

Minimum reset signal width	Output delay time
1 ms	0.8 to 1.2 ms
20 ms	15 to 25 ms

H5CX-A□-N/-L□-N

Connections

Block Diagram

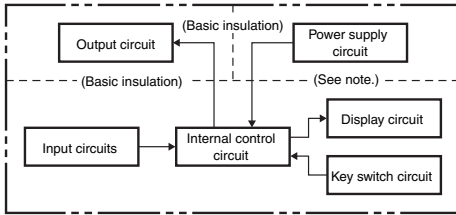

Note: Basic insulation is provided between the power supply circuit and the input circuits. However, basic insulation is not provided in the H5CX-□D-N.

Terminal Arrangement

Confirm that the power supply meets specifications before use.

H5CX-A-N/-AD-N	H5CX-AS-N/-ASD-N
<p>Terminals 1 and 6 of the H5CX-AD-N are connected internally.</p>	<p>Terminals 1 and 6 of the H5CX-ASD-N are connected internally.</p>
H5CX-A11-N/-A11D-N	H5CX-A11S-N/-A11SD-N
<p>Terminals 2 and 3 of the H5CX-A11D-N are connected internally.</p>	<p>Terminals 2 and 3 of the H5CX-A11SD-N are connected internally.</p>
H5CX-L8-N/-L8D-N	H5CX-L8S-N/-L8SD-N
<p>Terminals 1 and 2 of the H5CX-L8D-N are connected internally.</p>	<p>Terminals 1 and 2 of the H5CX-L8SD-N are connected internally.</p>
H5CX-L8E-N/-L8ED-N	

Note: Do not connect unused terminals as relay terminals.

Transistor Output

- The transistor output of the H5CX is insulated from the internal circuitry by a photocoupler, so the transistor output can be used as both NPN and PNP output.
- The diode connected to the collector of the output transistor is used to absorb inverted voltage that is generated when an inductive load is connected to the H5CX.

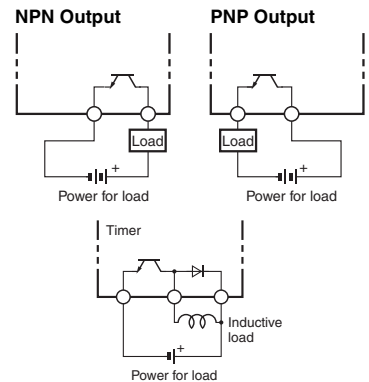

Input Circuits

Signal, Reset, and Gate Input

No-voltage Inputs (NPN Inputs)

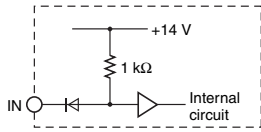

Voltage Inputs (PNP Inputs)

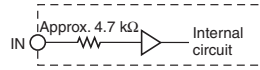

Input Connections

The inputs are no-voltage (closed or open) inputs or voltage inputs except for the H5CX-L8□. (The inputs of the H5CX-L8□ are no-voltage inputs only. The H5CX-L8E□ does not have an input.)

No-voltage Inputs (NPN Inputs)

Open Collector

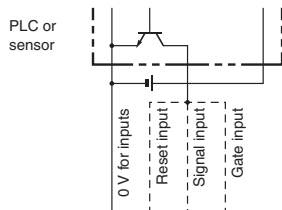

H5CX-A□	6	7	8	9
H5CX-A11□	3	7	6	5
H5CX-L8□	1	3	4	-

Note: Operate with transistor ON

Voltage Output

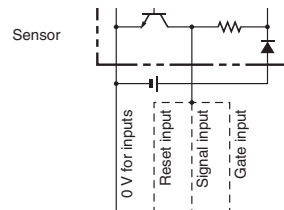

H5CX-A□	6	7	8	9
H5CX-A11□	3	7	6	5
H5CX-L8□	1	3	4	-

Note: Operate with transistor ON

Contact Input

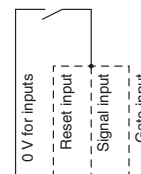

H5CX-A□	6	7	8	9
H5CX-A11□	3	7	6	5
H5CX-L8□	1	3	4	-

Note: Operate with relay ON

DC Two-wire Sensor

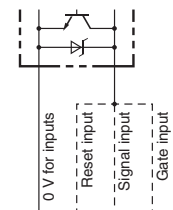

H5CX-A□	6	7	8	9
H5CX-A11□	3	7	6	5
H5CX-L8□	1	3	4	-

Note: Operate with transistor ON

No-voltage Input Signal Levels

No-contact input	Short-circuit level Transistor ON
	<ul style="list-style-type: none"> Residual voltage: 3 V max. Impedance when ON: 1 kΩ max. (The leakage current is approx. 12 mA when the impedance is 0 Ω.)
Contact input	Open level Transistor OFF
	<ul style="list-style-type: none"> Impedance when OFF: 100 kΩ min. Use contacts which can adequately switch 5 mA at 10 V

Note: The DC voltage must be 30 VDC max.

Applicable Two-wire Sensor

- Leakage current: 1.5 mA max.
- Switching capacity: 5 mA min.
- Residual voltage: 3.0 VDC max.
- Operating voltage: 10 VDC

Voltage Inputs (PNP Inputs) The inputs of the H5CX-L8□ are no-voltage inputs only.

No-contact Input (NPN Transistor)

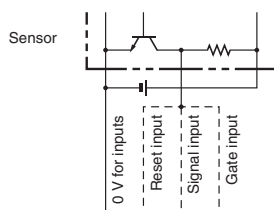

H5CX-A□	6	7	8	9
H5CX-A11□	3	7	6	5

Note: Operate with transistor OFF

No-contact Input (PNP Transistor)

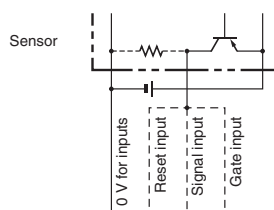

H5CX-A□	6	7	8	9
H5CX-A11□	3	7	6	5

Note: Operate with transistor ON

Contact Input

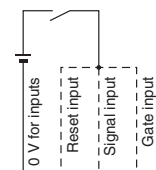

H5CX-A□	6	7	8	9
H5CX-A11□	3	7	6	5

Note: Operate with relay ON

Voltage Input Signal Levels

High level (Input ON): 4.5 to 30 VDC
Low level (Input OFF): 0 to 2 VDC

Note: 1. The DC voltage must be 30 VDC max.
2. Input resistance: Approx. 4.7 kΩ

H5CX-A□-N/-L□-N

Nomenclature

Display Section

1. Key Protect Indicator (orange)
2. Control Output Indicator (orange)
3. Reset Indicator (orange)
4. Present Value Display (Main display)
(Character height: 12 mm, red *)
* Characters on models with screw terminals (H5CX-A□) can be switched between red, green, and orange.
5. Time Unit Indicators
(Color is same as present value display.)
(If the time range is 0 min, 0 h, 0.0 h, or 0 h 0 min, these indicators flash to indicate timing operation.)
6. Set Value Display (Sub-display)
(Character height: 6 mm, green)
7. Set Value 1, 2 Indicator (green)

Character Size for Present Value Display

Character Size for Set Value Display

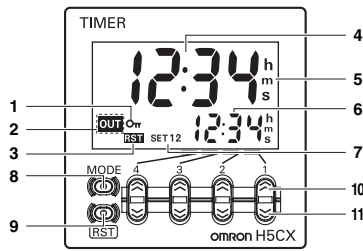
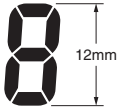

Front View

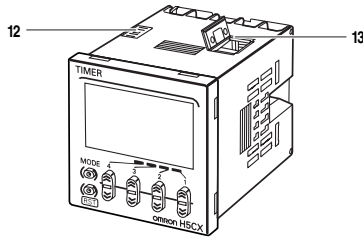

Operation Key

8. Mode Key
(Changes modes and setting items)
9. Reset Key
(Resets present value and output)
10. Up Keys 1 to 4
11. Down Keys 1 to 4

Switches

12. Key-protect Switch

(Default setting) OFF (Disabled) ↔ ON (Enabled)

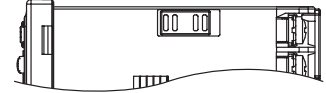

13. DIP Switch

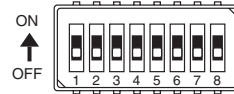

Note: There is no DIP switch on the H5CX-L8□.

Dimensions

(unit: mm)

Digital Timers

Digital Timers

H5CX-A-N/-AS-N (Flush Mounting Models)

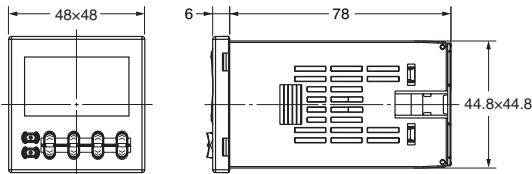
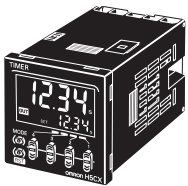

Note: M3.5 terminal screw (effective length: 6 mm)

H5CX-AD-N/-ASD-N (Flush Mounting Models)

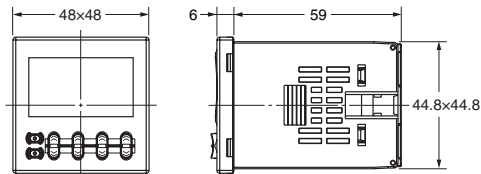
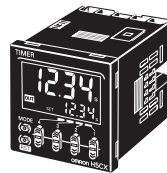

Note: M3.5 terminal screw (effective length: 6 mm)

H5CX-A11□-N

(Flush Mounting/Surface Mounting Models)

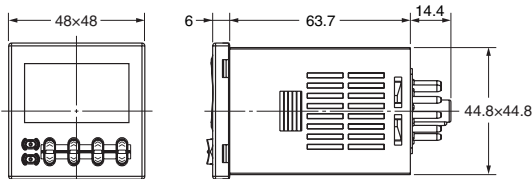

H5CX-L8□-N (Flush Mounting/Surface Mounting Models)

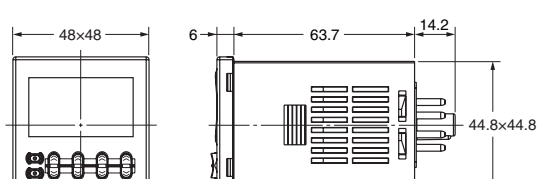

Dimensions with Flush Mounting Adapter

H5CX-A-N/-AS-N (Provided with Adapter and Waterproof Packing)

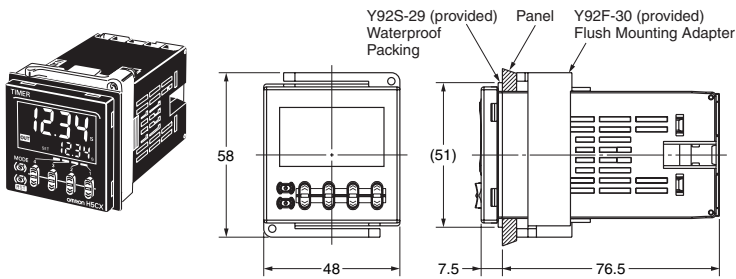

Panel Cutouts

Panel cutouts areas shown below. (according to DIN43700).

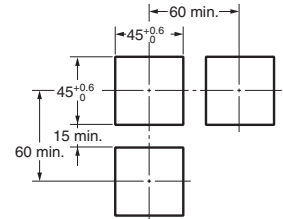

- Note:**
1. The mounting panel thickness should be 1 to 5 mm.
 2. To allow easier operation, it is recommended that Adapters be mounted so that the gap between sides with hooks is at least 15 mm (i.e., with the panel cutouts separated by at least 60 mm).
 3. It is possible to horizontally mount Timers side by side. Attach the Flush Mounting Adapters so that the surfaces without hooks are on the sides of the Timers. (However, if Timers are mounted side by side, water resistance will be lost.)

H5CX-AD-N/-ASD-N (Provided with Adapter and Waterproof Packing)

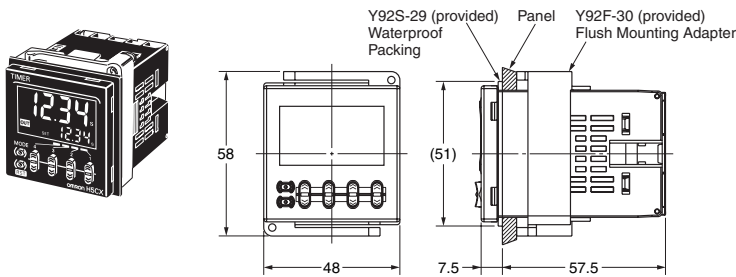

H5CX-A11□-N (Adapter and Waterproof Packing Ordered Separately)

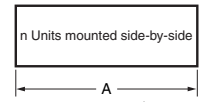
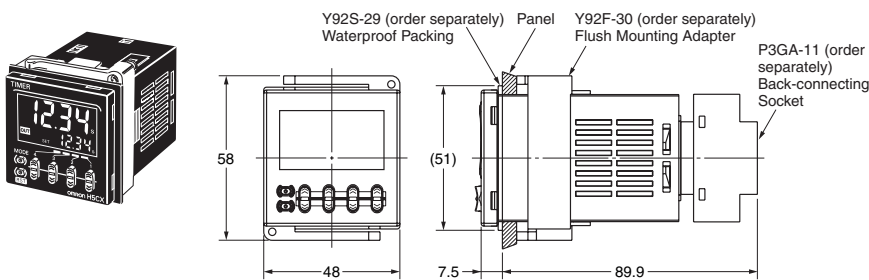

$$A = (48n - 2.5) \begin{matrix} +1 \\ -0 \end{matrix}$$

With Y92A-48F1 attached.

$$A = \{48n - 2.5 + (n-1) \times 4\} \begin{matrix} +1 \\ -0 \end{matrix}$$

With Y92A-48 attached.

$$A = (51n - 5.5) \begin{matrix} +1 \\ -0 \end{matrix}$$

Dimensions with Front Connecting Socket

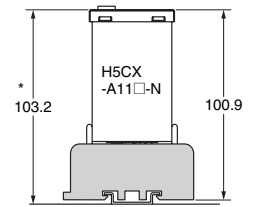

P2CF-11(-E) (order separately) Front Connecting Socket

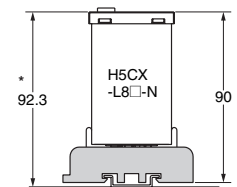

P2CF-08(-E) (order separately) Front Connecting Socket

* These dimensions vary with the type of DIN track (reference value).

H5CX-L8□-N (Adapter and Waterproof Packing Ordered Separately)

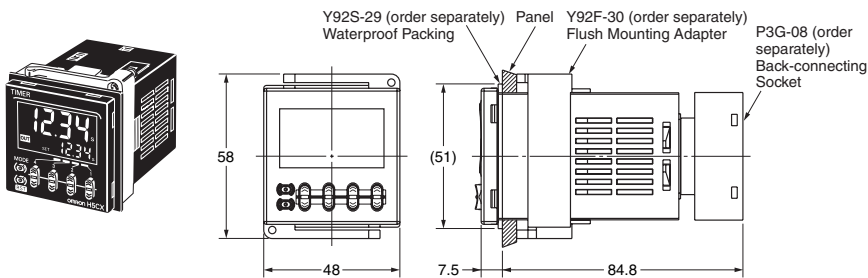

Accessories (Order Separately)

Note:

Depending on the operating environment, the condition of resin products may deteriorate, and may shrink or become harder. Therefore, it is recommended that resin products are replaced regularly.

Front Panel (Replacement Part)

You can change the color of the front panel when mounting the Timer. The Timer is shipped with a black (N1.5) Front Panel.

Y92P-CXT4S

Cover for Timer with 4 Digits
White (5Y9.2/0.5)

Y92P-CXT4G

Cover for Timer with 4 Digits
Light gray (5Y7/1)

Y92P-CXT4B

Cover for Timer with 4 Digits
Black (N1.5)



Replacement Method

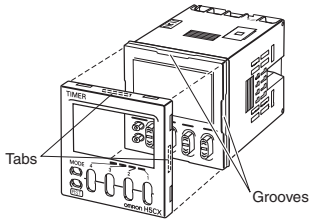

The Front Panel is attached to the Terminal with tabs in four locations. To remove the Front Panel, open the tabs and pull the Front Panel forward. To attach the Front Panel, press it onto the Timer so that all four tabs lodge into the grooves on the body of the Timer.

**Soft Cover
Y92A-48F1**

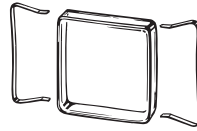

**Hard Cover
Y92A-48**

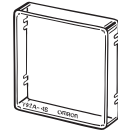

Protecting the Timer in Environments Subject to Oil

The H5CX's panel surface is water-resistant (IP□6, UL Type 4X) and so even if drops of water penetrate the gaps between the keys, there will be no adverse effect on internal circuits. If, however, there is a possibility of oil being present on the operator's hands, use the Soft Cover. The Soft Cover ensures protection equivalent to IP54 against oil. Do not, however, use the H5CX in locations where it would come in direct contact with oil.

**Flush Mounting Adapter
Y92F-30**

Order the Flush Mounting Adapter separately if it is lost or damaged.

Note: A Flush Mounting Adapter is included with models with screw terminals.

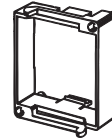

Y92F-45

Use this Adapter to install the Timer in a cutout previously made for a DIN 72 x 72 mm device (panel cutout: 68 x 68 mm).

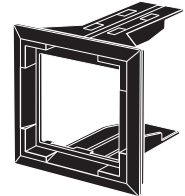

**Waterproof Packing
Y92S-29**

Note: The Waterproof Packing is included with models with screw terminals.



Order the Waterproof Packing separately if it is lost or damaged. The Waterproof Packing can be used to achieve IP66 protection.

The Waterproof Packing will deteriorate, harden, and shrink depending on the application environment. To ensure maintaining the IP□6, UL Type 4X waterproof level, periodically replace the Waterproof Packing. The periodic replacement period will depend on the application environment. You must confirm the proper replacement period. Use 1 year or less as a guideline. If the Waterproof Packing is not replaced periodically, the waterproof level will not be maintained.

It is not necessary to mount the Waterproof Packing if waterproof construction is not required.

Connection Sockets
Front-connecting Sockets

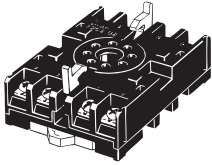
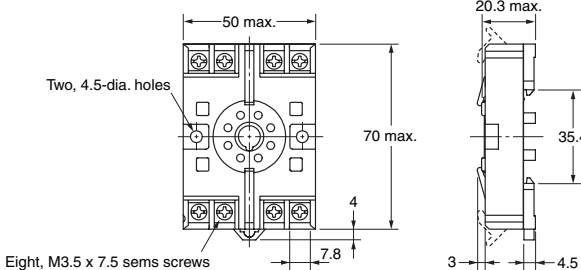
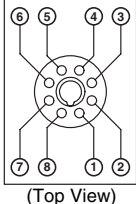
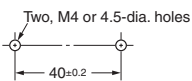
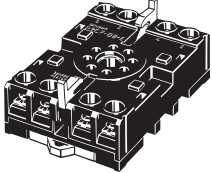
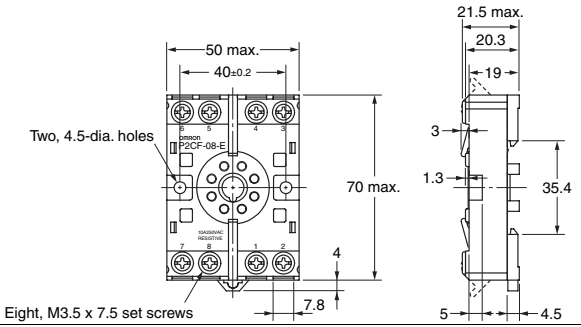
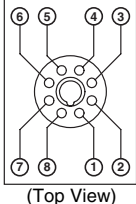
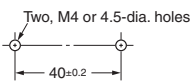
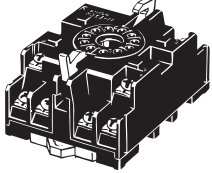
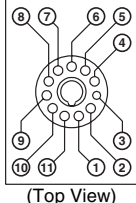
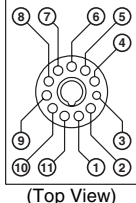
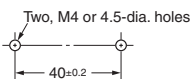
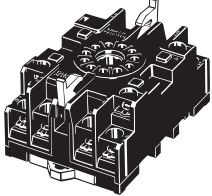
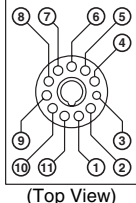
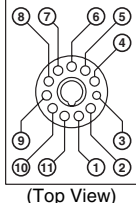
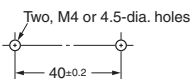
Model	Dimensions	Terminal arrangement and internal connections	Mounting hole dimensions
 P2CF-08		 (Top View)	 <p>Note: The Socket can also be mounted to DIN track.</p>
 P2CF-08-E (Finger Safe Terminal)		 (Top View)	 <p>Note: The Socket can also be mounted to DIN track.</p>
 P2CF-11		 (Top View)	 <p>Note: The Socket can also be mounted to DIN track.</p>
 P2CF-11-E (Finger Safe Terminal Type)		 (Top View)	 <p>Note: The Socket can also be mounted to DIN track.</p>

Note: Round crimp terminals cannot be used on Finger-safe Sockets. Use forked crimp terminals.

Back-connecting Sockets

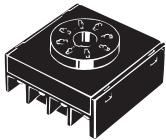
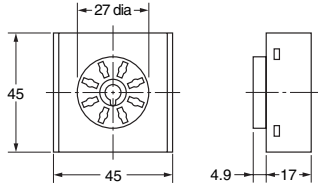
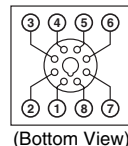
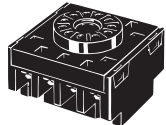
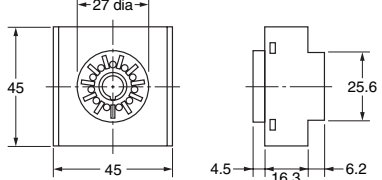
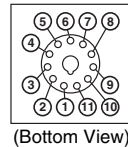
Model	Dimensions	Terminal arrangement and internal connections
 P3G-08		 (Bottom View)
 P3GA-11		 (Bottom View)

Note: A Y92A-48G Terminal Cover can be used with the Socket to create a finger-safe construction.

H5CX-A□-N/-L□-N

Terminal Covers for P3G-08 and P3GA-11 Back-connecting Sockets

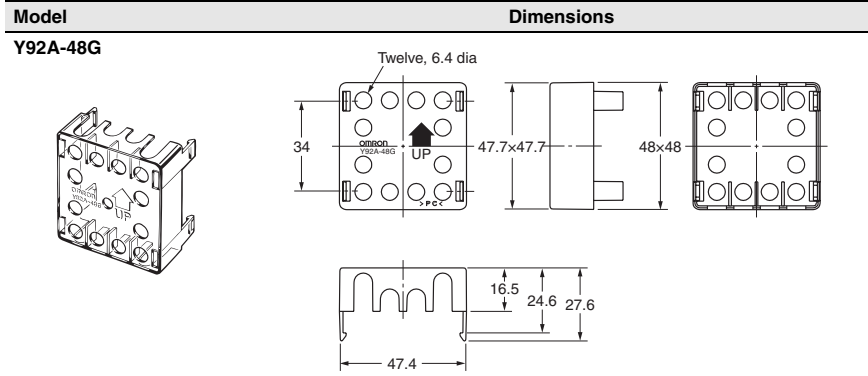

Note: The Terminal Cover can be used with a Back-mounting Socket (P3G-08 or P3GA-11) to create a finger-safe construction.

Optional Products for Track Mounting

Mounting Track

PFP-100N
PFP-50N

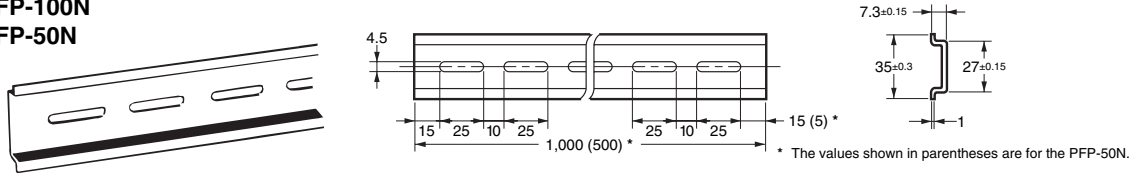

Mounting Track

PFP-100N2

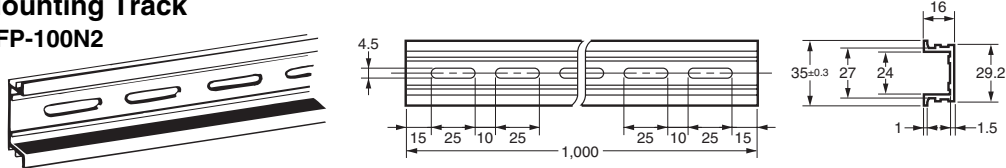

End Plate

PFP-M

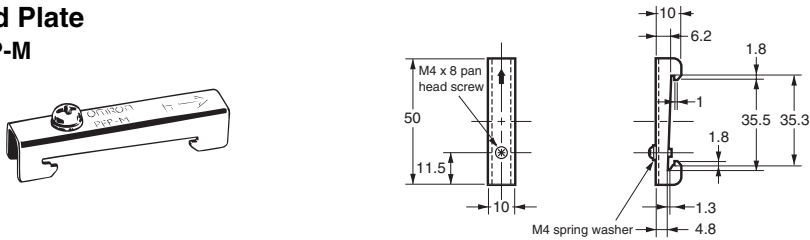

Spacer

PFP-S

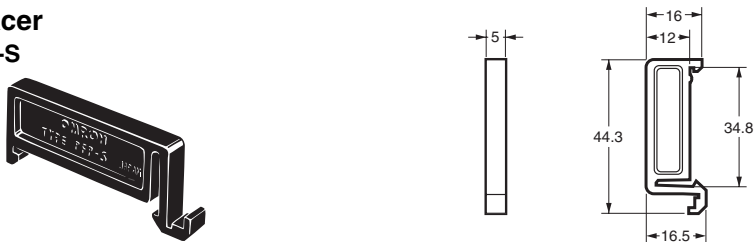

Note: Order Spacers in increments of 10.

Operating Procedures

Setting Procedure Guide

Settings for Timer Operation *

Use the following settings.

Settings for Twin Timer Operation *

Refer to **page 25**.

* It is not necessary to mount the Waterproof Packing if waterproof construction is not required.

Operating Procedures for Timer Function

Step1 Settings for basic functions can be performed with just the DIP switch.

Note: There is no DIP switch on the H5CX-L8□. Go to **Step2**.

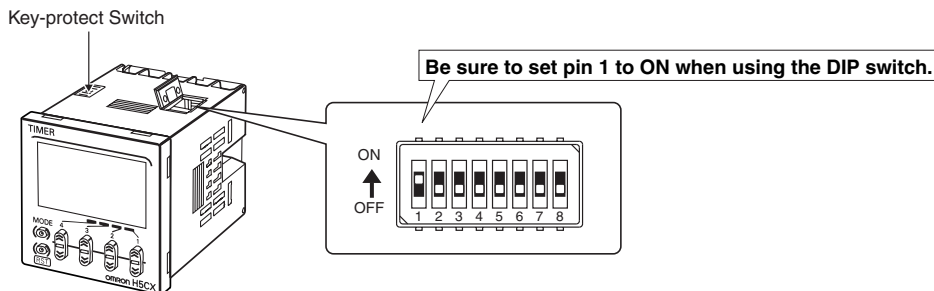

	Item	OFF	ON
1	DIP switch settings	Disabled	Enabled
2	Time range	Refer to the table on the right.	
3			
4	Output modes	Refer to the table on the right.	
5			
6	Timer mode	UP	DOWN
7	Input signal width	20 ms	1 ms
8			

Pin 2	Pin 3	Pin 4	Time range
ON	ON	ON	0.001 s to 9.999 s
OFF	OFF	OFF	0.01 s to 99.99 s
ON	OFF	OFF	0.1 s to 999.9 s
OFF	ON	OFF	1 s to 9999 s
ON	ON	OFF	0 min 01 s to 99 min 59 s
OFF	OFF	ON	0.1 min to 999.9 min
ON	OFF	ON	0 h 01 min to 99 h 59 min
OFF	ON	ON	0.1 h to 999.9 h

Note: All the pins are factory-set to OFF.

- Be sure to turn ON pin 1 of the DIP switch.
- Changes to DIP switch settings are enabled when the power is turned ON.
(Set the DIP switch while the power is OFF.)

Pin 5	Pin 6	Output mode
OFF	OFF	Mode A: Signal ON delay 1 (Timer resets when power comes ON.)
ON	OFF	Mode A-2: Power ON delay 1 (Timer resets when power comes ON.)
OFF	ON	Mode E: Interval (Timer resets when power comes ON.)
ON	ON	Mode F: Cumulative (Timer does not reset when power comes ON.)

After making DIP switch settings for basic operation, advanced functions can be added using the operation keys on the front panel. Refer to **Step2** on **page 16** for details.

Step2 Settings that cannot be performed with the DIP switch are performed with the operation keys.

- Change to Function Setting Mode.

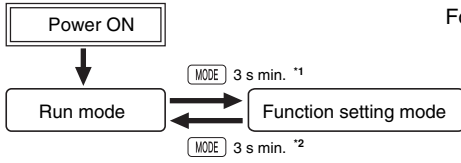

For details on operations in run mode, refer to **page 19**.

- *1. If the mode is switched to the function setting mode during operation, operation will continue.
- *2. Changes made to settings in function setting mode are enabled for the first time when the mode is changed to run mode. Also, when settings are changed, the timer is reset (time initialized and output turned OFF).

The characters displayed in reverse video are the default settings.
When performing settings with operation keys only, set pin 1 of the DIP switch to OFF (factory setting).
If pin 1 of the DIP switch is set to ON, the setting items indicated in will not be displayed.

Function setting mode

- Set the time range using the keys.

 → For details, refer to the **Time Range List**.
- Set the timer mode using the keys.
- Set the output mode using the keys.

Note: Only modes **A-2**, b, E, and Z can be selected for models with instantaneous contact outputs.
- Set each digit for the output time using the corresponding keys.

 (Output hold) (0.01s) (99.99s)
 (If the output time is set to 0.00, **Hold** is displayed.)
Note: Displayed for modes A, A-1, A-2, A-3, b, b-1 and S only.
- Set the input signal width using the keys.

 (20ms) (1ms)
Note: Not displayed for models with instantaneous contact outputs.
- Set the NPN/PNP mode using the keys.

 (NPN input) (PNP input)
Note: Only displayed for the H5CX-A□ and H5CX-A11□.
- Set the display color using the keys.

 (Red) (Green) (Orange) (Red-green) (Green-red) (Red-orange) (Orange-red) (Green-orange) (Orange-green)
Note: Displayed only for models with terminal screws (H5CX-A□).
- Set the function (instantaneous or time-limit operation) for the instantaneous output (output 1) using the Keys.

 (Instantaneous) (Time-limit)
Note: Displayed only for models with instantaneous contact outputs.

Time Range List	
Display	Set Value
	0.01 s to 99.99 s (default setting)
	0.1 s to 999.9 s
	1 s to 9999 s
	0 min 01 s to 99 min 59 s
	0.1 min to 999.9 min
	0 h 01 min to 99 h 59 min
	0.1 h to 999.9 h
	1 h to 9999 h
	0.001 s to 9.999 s

From next page To next page

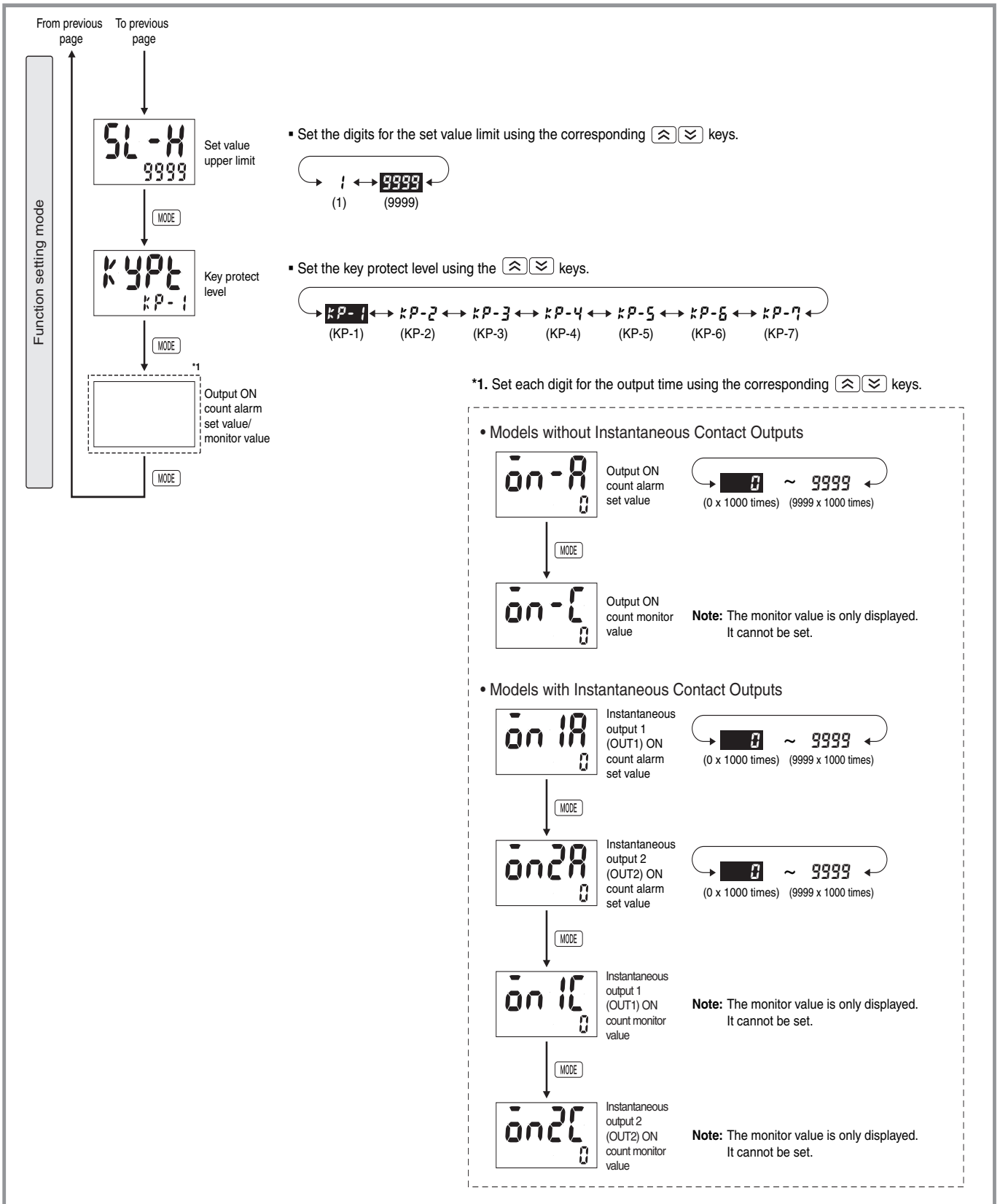

H5CX-A□-N/-L□-N Timer

Explanation of Functions

Operating Procedures for Timer Function

Items marked with stars (★) can be set using the DIP switch.

Time Range (t_{min}-t_{max})★

Set the range to be timed in the range 0.001 s to 9,999 h. Settings of type ---- h (9,999 h) and ---- min (9,999 min) cannot be made with the DIP switch. Use the operation keys if these settings are required.

Timer Mode (t_{min}-t_{max})★

Set either the elapsed time (UP) or remaining time (DOWN) mode. In UP mode, the elapsed time is displayed, and in DOWN mode, the remaining time is displayed.

Output Mode (o_{min}-o_{max})★

Set the output mode. The possible settings are A, A-1, A-2, A-3, b, b-1, d, E, F, Z and S. Only output modes A, A-2, E, and F can be set using the DIP switch. Use the operation keys if a different setting is required. (For details on output mode operation, refer to "Timing Charts" on page 20.)

Output Time (o_{min}-t_{max})

When using one-shot output, set the output time for one-shot output (0.01 to 99.99 s). One-shot output can be used only if the selected output mode is A, A-1, A-2, A-3, b, b-1 or S. If the output time is set to 0.00, H₀L₀ is displayed, and the output is held.

Input Signal Width (i_{min}-i_{max})★

Set the minimum signal input width (20 ms or 1 ms) for signal, reset, and gate inputs. The same setting is used for all external inputs (signal, reset, and gate inputs). If contacts are used for the input signal, set the input signal width to 20 ms. Processing to eliminate chattering is performed for this setting.

NPN/PNP Input Mode (i_{min}-i_{max})

Select either NPN input (no-voltage input) or PNP input (voltage input) as the input format. Set an NPN input when using a 2-wire sensor. For details on input connections, refer to "Input Connections" on page 9.

Display Color (c_{min}-c_{max})

(Terminal block model: H5CX-A□ only)

Set the color used for the present value.

	Output OFF	Output ON
r ₀ E ₀ d	Red (fixed)	
g ₀ r ₀ n	Green (fixed)	
o ₀ r ₀ g	Orange (fixed)	
r ₀ -g	Red	Green
g ₀ -r	Green	Red
r ₀ -o	Red	Orange
o ₀ -r	Orange	Red
g ₀ -o	Green	Orange
o ₀ -g	Orange	Green

Key Protect Level (k_{min}-k_{max})

Set the key protect level. Refer to "Key Protect Level" on page 32.

Instantaneous/Time-limit (o_{min}-t_{max})

Set the contact output to time-limit SPDT + instantaneous SPDT or time-limit SPDT operation.

Set Value Upper Limit (s_{min}-s_{max})

Set the upper limit for the set value when it is set in Run Mode. The limit can be set to between 1 and 9999. This setting does not apply to the ON duty in Z mode.

Output ON Count Alarm Set Value (o_{min}-n_{max})

Set the alarm value for the output ON count. The limit can be set to between 0 x 1000 (0 times) and 9999 x 1000 (9,999,000 times). Only the underlined values are set. The alarm will be disabled if 0 is set. If the total ON count of the output exceeds the alarm set value, E₃ will be displayed on the Timer to indicate that the output ON count alarm value was exceeded. Refer to "Self-diagnostic Function" on page 32 for information on the E₃ display.

ON Count Alarm Set Values for Outputs 1 and 2 (OUT1 and OUT2) (o_{min} 1_{max} and o_{min} 2_{max})

Set the ON count alarm values for the outputs 1 and 2. The limit can be set to between 0 x 1000 (0 times) and 9999 x 1000 (9,999,000 times). Only the underlined values are set. The alarm will be disabled if 0 is set. If the total ON count of instantaneous output 1 or 2 exceeds the alarm set value, E₃ will be displayed on the Timer to indicate that the output ON count alarm value was exceeded. Refer to "Self-diagnostic Function" on page 32 for information on the E₃ display.

Output ON Count Monitor Value (o_{min}-m_{max})

The monitor value is only displayed. It cannot be set. The output ON count will be 1,000 times the displayed value.

ON Count Monitor Values for Outputs 1 and 2 (OUT1 and OUT2) (o_{min} 1_{max} and o_{min} 2_{max})

The monitor value for output 1 or 2 is only displayed. It cannot be set. The output ON count will be 1,000 times the displayed value.

Operation in Run Mode Operating Procedures for Timer Function

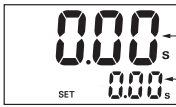

Present value

Set value

- Set each digit for the output time using the corresponding \uparrow \downarrow keys.



Note: H5CX-L8E□-N Precautions
Set the Timer's set value before using the Timer in a self-holding circuit.

- When Output Mode Z Is Selected





Present value

ON duty ratio

- Set each digit for the output time using the corresponding \uparrow \downarrow keys. (The \uparrow \downarrow keys for the 4th digit cannot be used.)

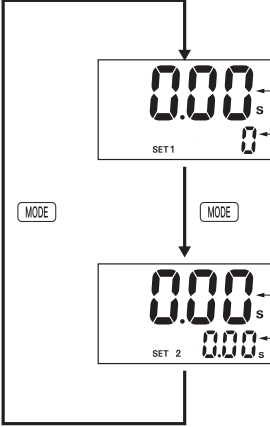





Present value

Cycle time

- Set each digit for the output time using the corresponding \uparrow \downarrow keys.



Present Value and Set Value

These items are displayed when the power is turned ON. The present value is displayed in the main display and the set value is displayed in the sub-display.

The values displayed will be determined by the settings made for the time range and the timer mode in function setting mode.

Present Value and ON Duty Ratio (Output Mode = Z)

The present value is displayed in the main display and the ON duty ratio is displayed in the sub-display. Set the ON duty ratio used in ON/OFF-duty-adjustable flicker mode (Z) as a percentage.

$$\text{ON time} = \text{Cycle time} \times \frac{\text{ON duty ratio} (\%)}{100}$$

The output accuracy will vary with the time range, even if the ON duty ratio setting is the same. Therefore, if fine output time adjustment is required, it is recommended that the time range for the cycle time is set as small as possible.

Examples: 1. When Time Range = - - - - s (9999 s)

$$20(\text{s}) \times \frac{31(\%)}{100} = 6.2(\text{s})$$

Rounded off to the nearest integer (because of the time range setting) → ON time = 6 s

2. When Time Range = - - . - - s (99.99 s)

$$20.00(\text{s}) \times \frac{31(\%)}{100} = 6.200(\text{s})$$

Rounded off to 2 decimal places (because of the time range setting) → ON time = 6.20 s

If a cycle time is set, cyclic control can be performed in ON/OFF-duty-adjustable flicker mode simply by changing the ON duty ratio.

Present Value and Cycle Time (Output Mode = Z)

The present value is displayed in the main display and the cycle time is displayed in the sub-display. Set the cycle time.

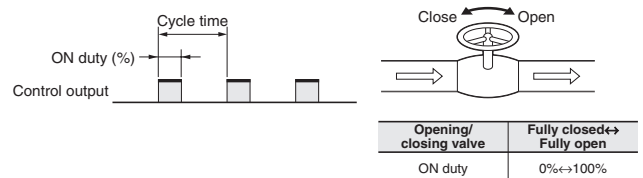
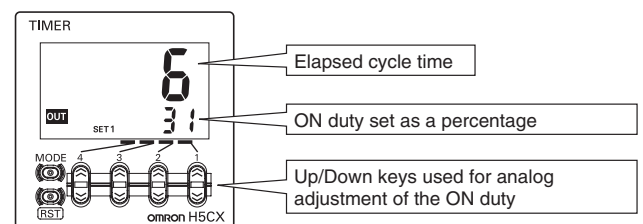

H5CX-A□-N/-L□-N Timer

Timing Charts

Operating Procedures for Timer Function

Models without Instantaneous Contact Outputs

The gate input is not included in the H5CX-L8□ models.

 Either one-shot output or sustained output can be selected.

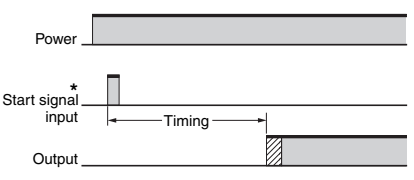
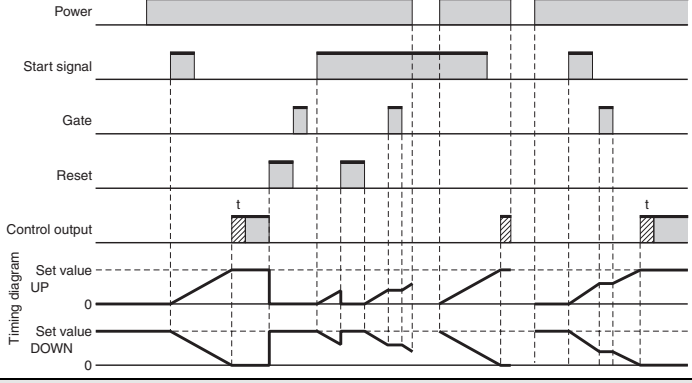
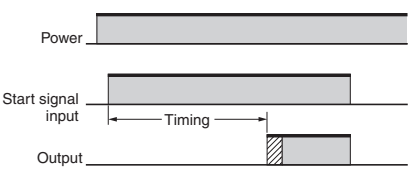
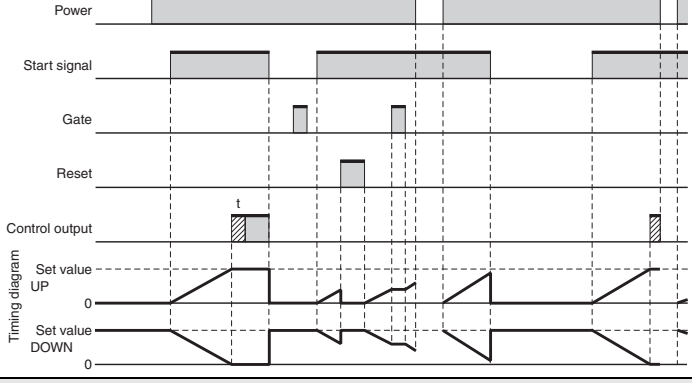
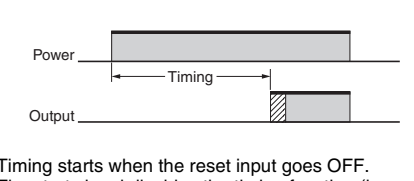
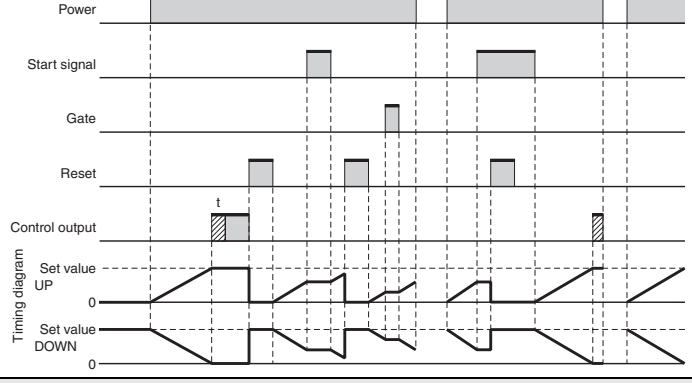
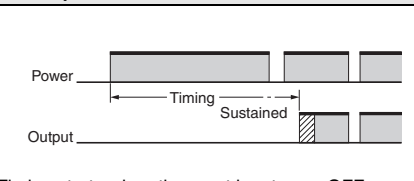
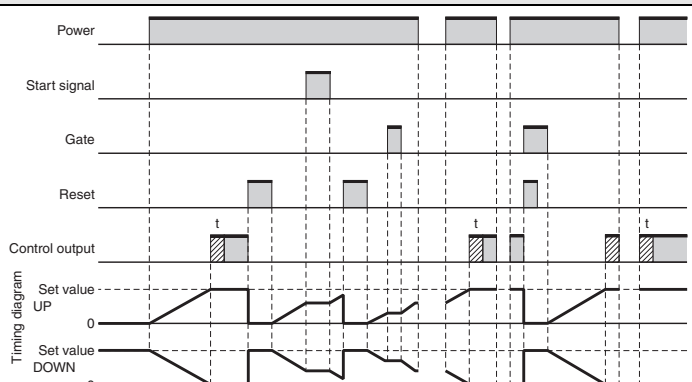
Mode A: Signal ON delay 1 (Timer resets when power comes ON.)	
Basic operation	Detailed operation
 <p>* Start signal input is disabled during timing.</p> <p>Timing starts when the start signal goes ON. While the start signal is ON, the timer starts when the power comes ON or when the reset input goes OFF. The control output is controlled using a sustained or one-shot time period.</p> <p>Note: Output is instantaneous when setting is 0.</p>	
Mode A-1: Signal ON delay 2 (Timer resets when power comes ON.)	
Basic operation	Detailed operation
 <p>Timing starts when the start signal goes ON, and resets when the start signal goes OFF. While the start signal is ON, the timer starts when the power comes ON or when the reset input goes OFF. The control output is controlled using a sustained or one-shot time period.</p> <p>Note: Output is instantaneous when setting is 0.</p>	
Mode A-2: Power ON delay 1 (Timer resets when power comes ON.)	
Basic operation	Detailed operation
 <p>Timing starts when the reset input goes OFF. The start signal disables the timing function (i.e., same function as the gate input). The control output is controlled using a sustained or one-shot time period.</p> <p>Note: Output is instantaneous when setting is 0.</p>	
Mode A-3: Power ON delay 2 (Timer does not reset when power comes ON.)	
Basic operation	Detailed operation
 <p>Timing starts when the reset input goes OFF. The start signal disables the timing function (i.e., same function as the gate input). The control output is controlled using a sustained or one-shot time period.</p> <p>Note: Output is instantaneous when setting is 0.</p>	

Mode b: Repeat cycle 1 (Timer resets when power comes ON.)

Basic operation

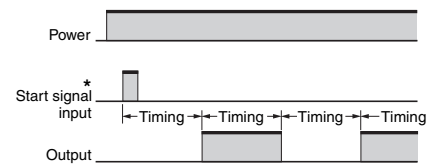

* Start signal input is disabled during timing.

Timing starts when the start signal goes ON.
The status of the control output is reversed when time is up (OFF at start).

While the start signal is ON, the timer starts when the power comes ON or when the reset input goes OFF.

Note: Normal output operation will not be possible if the set time is too short.
Set the value to at least 100 ms (contact output type).

Detailed operation

Sustained Output

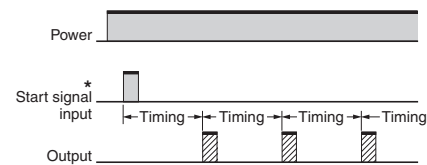
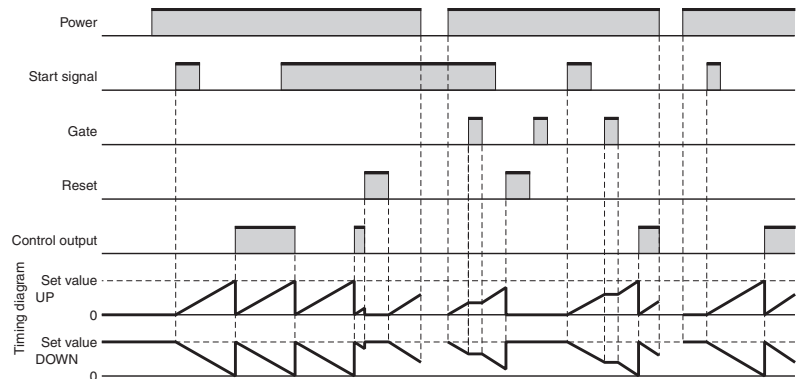

* Start signal input is disabled during timing.

Timing starts when the start signal goes ON.
The control output is turned ON when time is up.

While the start signal is ON, the timer starts when the power comes ON or when the reset input goes OFF.

Note: Normal output operation will not be possible if the set time is too short.
Set the value to at least 100 ms (contact output type).

One-shot Output

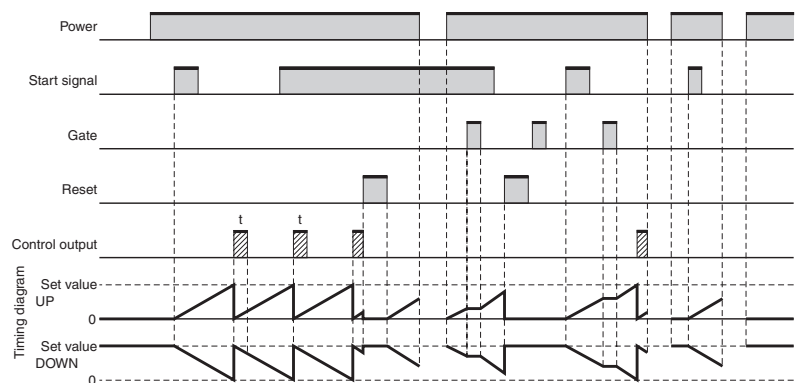

Mode b-1: Repeat cycle 2 (Timer does not reset when power comes ON.)

Basic operation

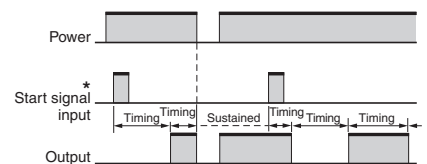

* Start signal input is disabled during timing.

Timing starts when the start signal goes ON.
The status of the control output is reversed when time is up (OFF at start).

While the start signal is ON, the timer starts when the power comes ON or when the reset input goes OFF.

Note: Normal output operation will not be possible if the set time is too short.
Set the value to at least 100 ms (contact output type).

Detailed operation

Sustained Output

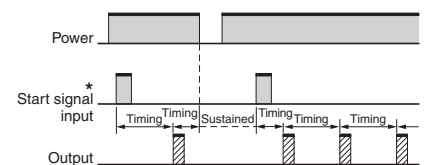
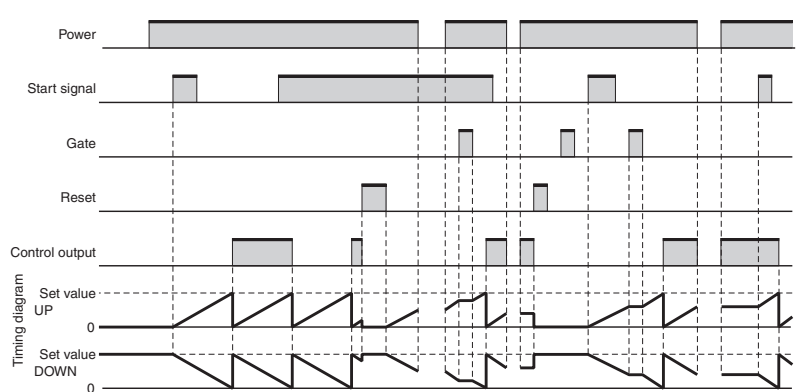

* Start signal input is disabled during timing.

Timing starts when the start signal goes ON.
The control output is turned ON when time is up.

While the start signal is ON, the timer starts when the power comes ON or when the reset input goes OFF.

Note: Normal output operation will not be possible if the set time is too short.
Set the value to at least 100 ms (contact output type).

One-shot Output

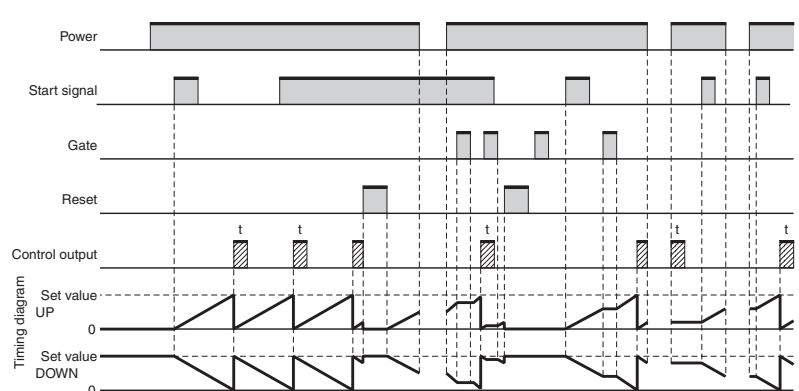

H5CX-A□-N/-L□-N Timer

Mode d: Signal OFF delay (Timer resets when power comes ON.)

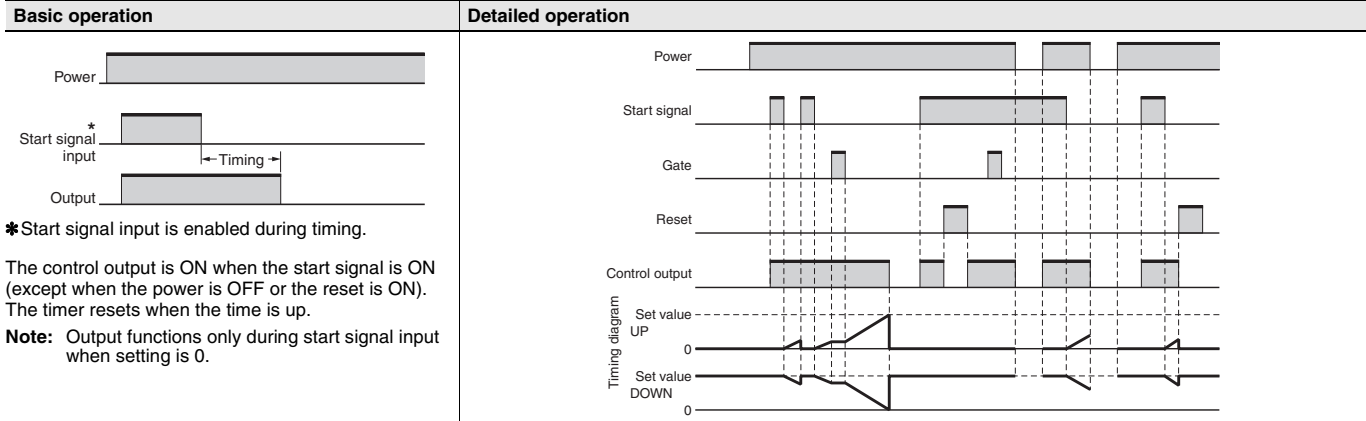

Mode E: Interval (Timer resets when power comes ON.)

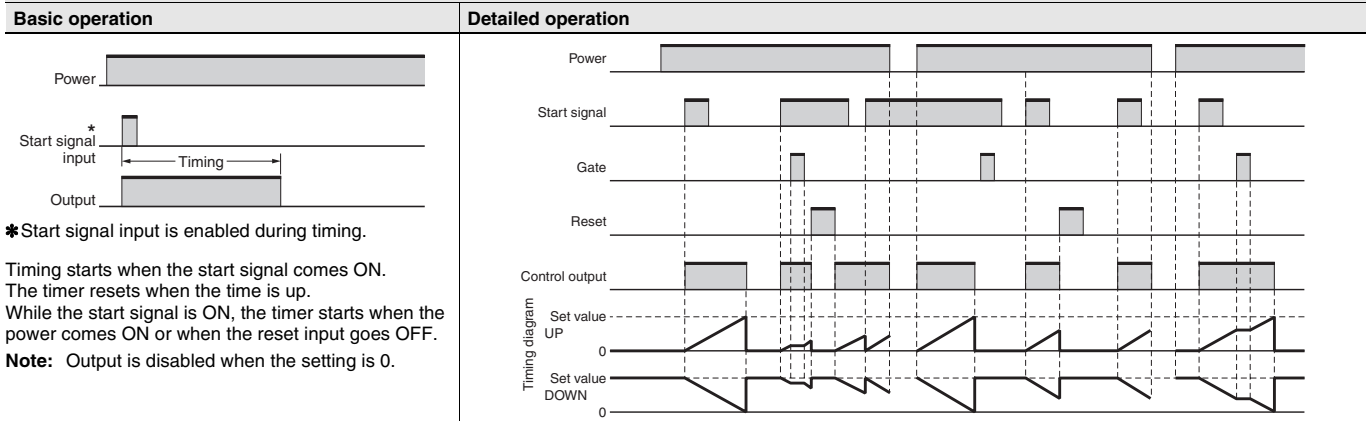

Mode F: Cumulative (Timer does not reset when power comes ON.)

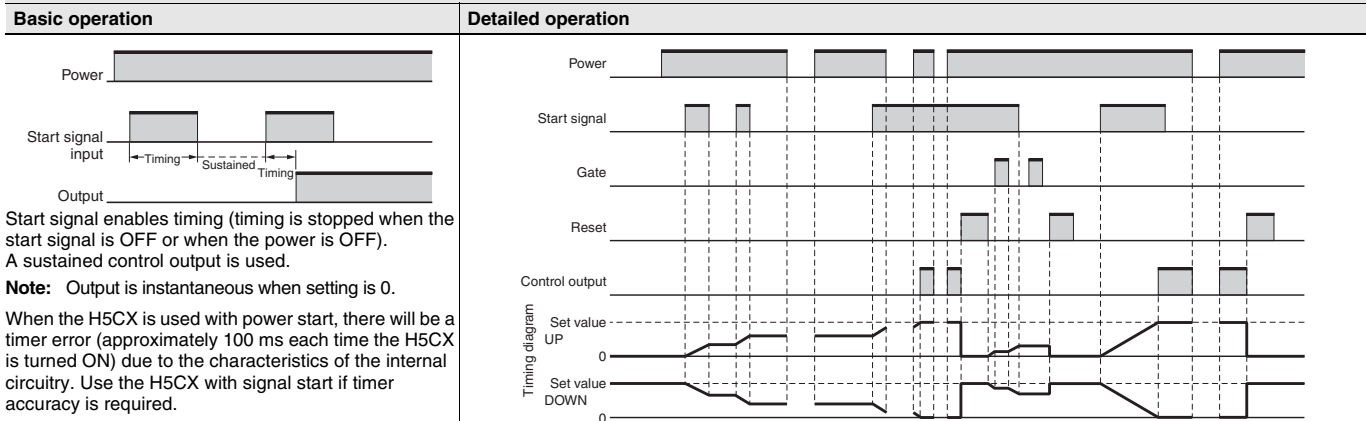

Mode Z: ON/OFF-duty-adjustable flicker (Timer resets when power comes ON.)

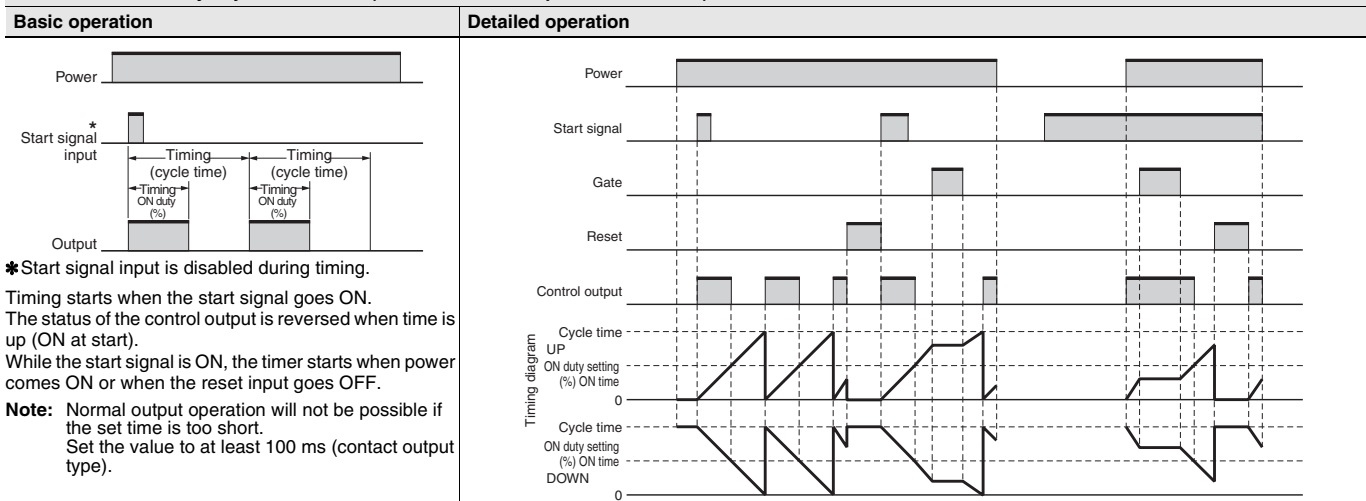

Mode S: Stopwatch (Timer resets when power comes ON.)

Basic operation

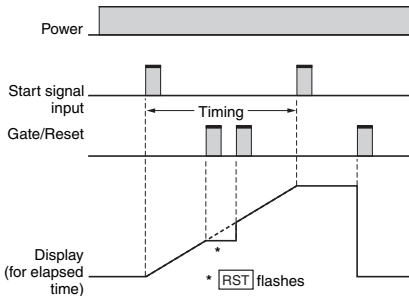

The signal starts and stops timing.
The display is held and timing is continued if the reset or gate input is received during timing operation.
The timer resets if the reset or gate input is received when the timing operation is stopped.

Note: Output is instantaneous when setting is 0.

Detailed operation

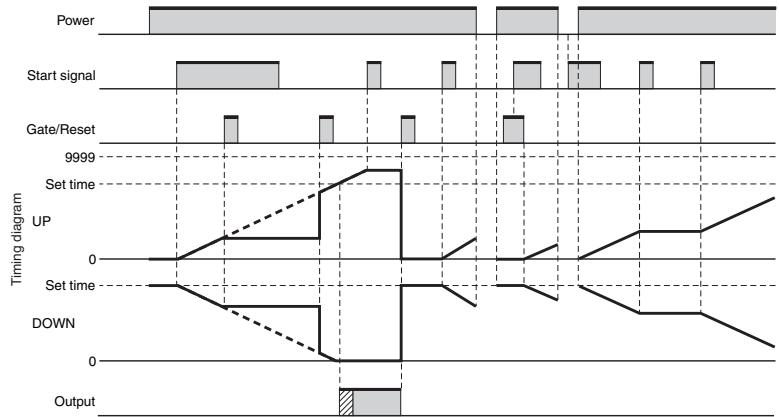

Models with Instantaneous Contact Outputs

Either one-shot output or sustained output can be selected.

Mode A-2: Power ON delay (Timer resets when power comes ON.)

Basic operation

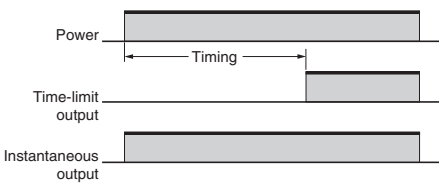

The Timer starts when the power comes ON or when the reset input goes OFF.

Note: Output is instantaneous when setting is 0.

Detailed operation

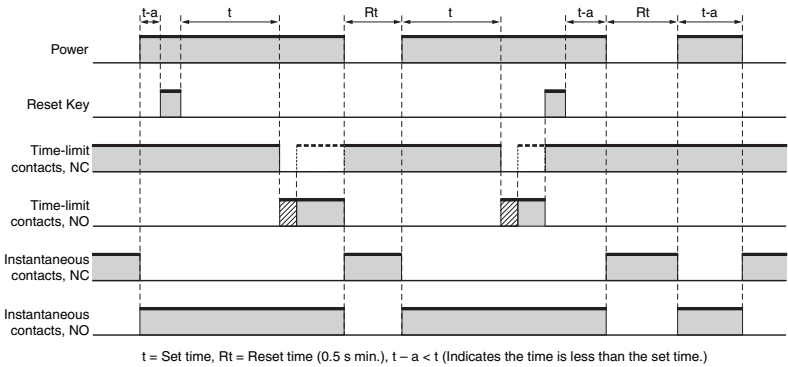

t = Set time, R_t = Reset time (0.5 s min.), $t - a < t$ (Indicates the time is less than the set time.)

Mode b: Repeat cycle 1 (Timer resets when power comes ON.)

Basic operation

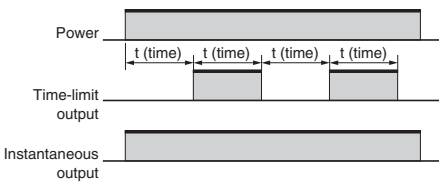

The Timer starts when the power comes ON or when the reset input goes OFF.

Note: Normal output operation will not be possible if the set time is too short.
Set the value to at least 100 ms.

Detailed operation

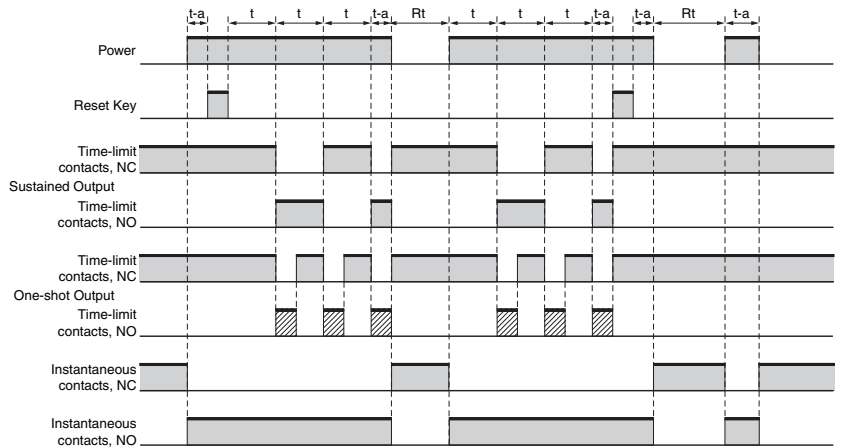

t = Set time, R_t = Reset time (0.5 s min.), $t - a < t$ (Indicates the time is less than the set time.)

Note: H5CX-L8E□-N Precautions

Set the Timer's set value before using the Timer in a self-holding circuit.

H5CX-A□-N/-L□-N Timer

Mode E: Interval (Timer resets when power comes ON.)

Basic operation

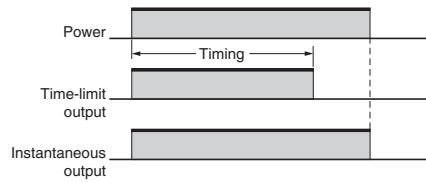

The Timer starts when the power comes ON or when the reset input goes OFF.

Note: Output is not instantaneous when setting is 0.

Detailed operation

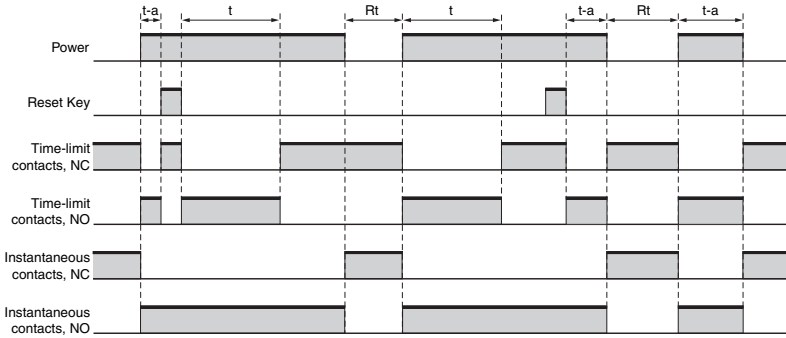

t = Set time, Rt = Reset time (0.5 s min.), t - a < t (Indicates the time is less than the set time.)

Mode Z: ON/OFF-duty adjustable flicker (Timer resets when power comes ON.)

Basic operation

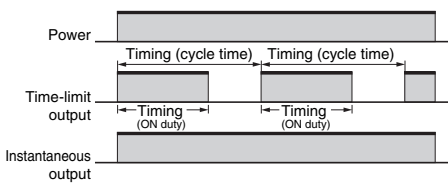

The Timer starts when the power comes ON or when the reset input goes OFF.

Note: Normal output operation will not be possible if the set time is too short.
Set the value to at least 100 ms.

Detailed operation

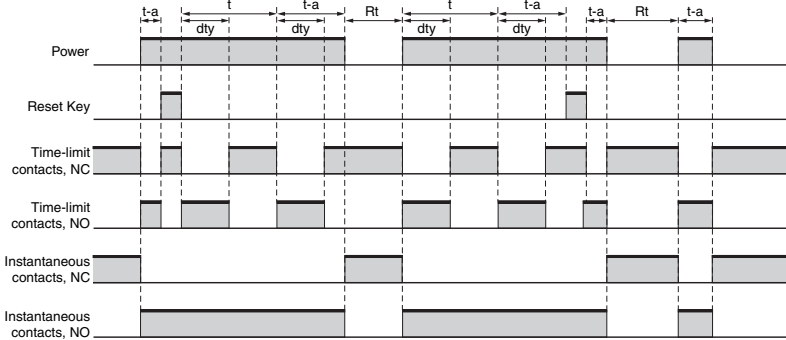

t = Set time, dty = ON duty time, Rt = Reset time (0.5 s min.), t - a < t (Indicates the time is less than the set time.)

Note: H5CX-L8E□-N Precautions

Set the Timer's set value before using the Timer in a self-holding circuit.

Setting Procedure Guide

Operating Procedures for Twin Timer Function

Step1 Switching to a Twin Timer

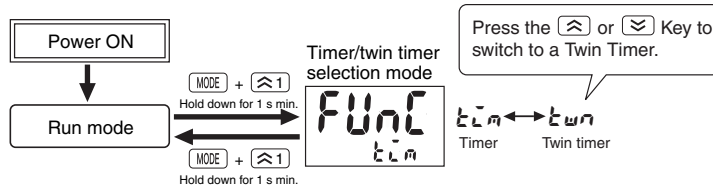

Step2 Settings for basic functions can be performed with just the DIP switch.

Note: There is no DIP switch on the H5CX-L8□. Go to **Step3**.

Key-protect Switch

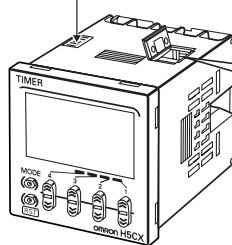

Be sure to set pin 1 to ON when using the DIP switch.

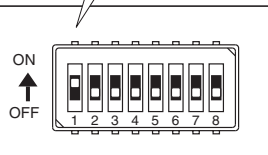

	Item	OFF	ON
1	DIP switch settings	Disabled	Enabled
2	OFF time range	Refer to the table on the right.	
3			
4	ON time range	Refer to the table on the right.	
5			
6	Output mode	Flicker OFF start	Flicker ON start
7	Timer mode	UP	DOWN
8	Input signal width	20 ms	1 ms

Pin 2	Pin 3	OFF time range
OFF	OFF	0.01 s to 99.99 s
ON	OFF	0.1 s to 999.9 s
OFF	ON	1 s to 9999 s
ON	ON	0 min 01 s to 99 min 59 s

Pin 4	Pin 5	ON time range
OFF	OFF	0.01 s to 99.99 s
ON	OFF	0.1 s to 999.9 s
OFF	ON	1 s to 9999 s
ON	ON	0 min 01 s to 99 min 59 s

Note: All the pins are factory-set to OFF.

- Be sure to turn ON pin 1 on the DIP switch.
- Changes to DIP switch settings are enabled when the power is turned ON. (Perform DIP switch settings while the power is OFF.)

After making DIP switch settings for basic operation, advanced functions can be added using the operation keys on the front panel. Refer to **Step3** on page 26 for details.

H5CX-A□-N/-L□-N Twin Timer

To switch to twin timer operation, use the procedure given below. For details, refer to page 31.

Step3 Settings that cannot be performed with the DIP switch are performed with the operation keys.

- Change to Function Setting Mode.

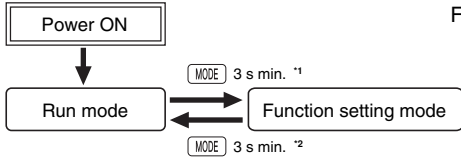

For details on operations in run mode, refer to page 28.

- *1. If the mode is switched to the function setting mode during operation, operation will continue.
- *2. Changes made to settings in function setting mode are enabled for the first time when the mode is changed to run mode. Also, when settings are changed, the timer is reset (time initialized and output turned OFF).

The characters displayed in reverse video are the default settings. When performing settings with operation keys only, set pin 1 of the DIP switch to OFF (factory setting). If pin 1 of the DIP switch is set to ON, the setting items indicated in will not be displayed.

Function setting mode

Power ON → Run mode → Function setting mode

Function setting mode sequence:

- OFF time range: -.-.-s
- ON time range: -.-.-s
- Timer mode: tmm UP
- ON/OFF start mode: töt tōff
- Input signal width: 20ms
- NPN/PNP input: imod nPn
- Display color: Cōl rEd
- Instantaneous/time-limit: ōtmd 1E 1E

- Set the OFF time range using the \uparrow \downarrow keys.
 - For details, refer to **Time Range List**.
- Set the ON time range using the \uparrow \downarrow keys.
 - For details, refer to **Time Range List**.
- Set the timer mode using the \uparrow \downarrow keys.
 - UP (UP) ↔ DOWN (DOWN)
- Set the twin timer output mode using the \uparrow \downarrow keys.
 - tōff ↔ tōn ↔ tōf1 ↔ tōn1
 - (Flicker OFF start 1) (Flicker ON start 1) (Flicker OFF start 2) (Flicker ON start 2)
 - Note:** Only Flicker OFF Start 1 or Flicker ON Start 1 can be selected for the H5CX-L8E□.
- Set the input signal width using the \uparrow \downarrow keys.
 - 20ms (20 ms) ↔ 1ms (1 ms)
 - Note:** Not displayed for models with instantaneous contact outputs.
- Set the NPN/PNP input mode using the \uparrow \downarrow keys.
 - nPn (NPN input) ↔ PnP (PNP input)
 - Note:** Displayed only for the H5CX-A□ and H5CX-A11□.
- Set the display color using the \uparrow \downarrow keys.
 - rEd (Red) ↔ Grn (Green) ↔ Orng (Orange) ↔ R-G (Red-green) ↔ G-R (Green-red) ↔ R-O (Red-orange) ↔ O-R (Orange-red) ↔ G-O (Green-orange) ↔ O-G (Orange-green)
 - Note:** Displayed only for models with terminal screws (H5CX-A□).
- Set the function (instantaneous or time-limit operation) for the instantaneous output (output 1) using the \uparrow \downarrow Keys.
 - 1E 1E (Instantaneous) ↔ 2E (Time-limit)
 - Note:** Displayed only for models with instantaneous contact outputs.

Display	Set Value
-.-.-s	0.01 s to 99.99 s (default setting)
-.-.-s	0.1 s to 999.9 s
-.-.-s	1 s to 9999 s
-.-.-m	0 min 01 s to 99 min 59 s
-.-.-m	0.1 min to 999.9 min
-.-.-m	1 min to 9999 min
-.-.-h	0 h 01 min to 99 h 59 min
-.-.-h	0.1 h to 999.9 h
-.-.-h	1 h to 9999 h
-.-.-s	0.001 s to 9.999 s

To next page From next page

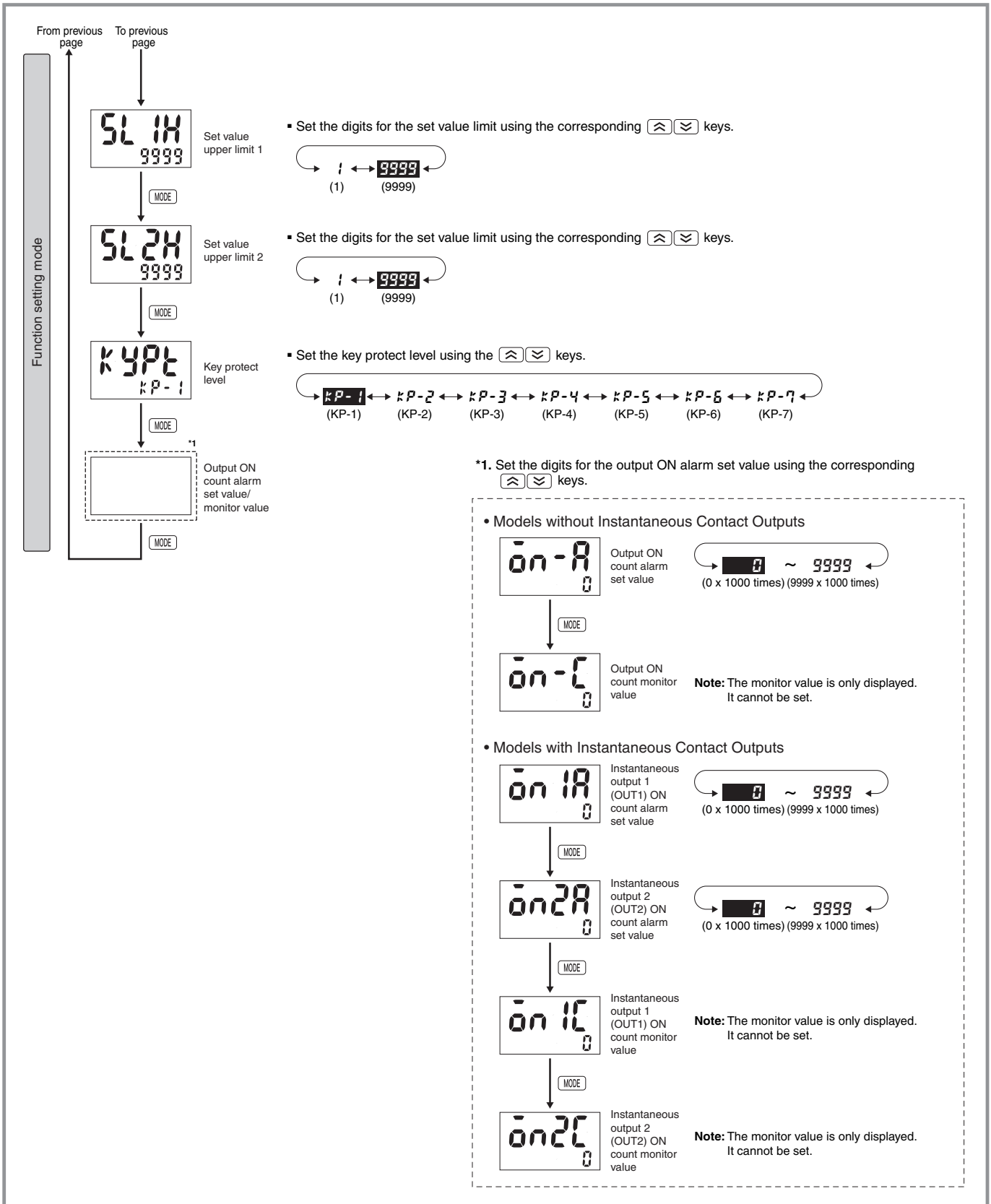

- Set the digits for the set value limit using the corresponding keys.

1
↔
9999

(1) (9999)
- Set the digits for the set value limit using the corresponding keys.

1
↔
9999

(1) (9999)
- Set the key protect level using the keys.

KP-1
↔
KP-2
↔
KP-3
↔
KP-4
↔
KP-5
↔
KP-6
↔
KP-7

(KP-1) (KP-2) (KP-3) (KP-4) (KP-5) (KP-6) (KP-7)

*1. Set the digits for the output ON alarm set value using the corresponding keys.

- Models without Instantaneous Contact Outputs

ōn-A
0

Output ON count alarm set value

0
~
9999

(0 x 1000 times) (9999 x 1000 times)

MODE

ōn-L
0

Output ON count monitor value

Note: The monitor value is only displayed. It cannot be set.
- Models with Instantaneous Contact Outputs

ōn 1A
0

Instantaneous output 1 (OUT1) ON count alarm set value

0
~
9999

(0 x 1000 times) (9999 x 1000 times)

MODE

ōn 2A
0

Instantaneous output 2 (OUT2) ON count alarm set value

0
~
9999

(0 x 1000 times) (9999 x 1000 times)

MODE

ōn 1L
0

Instantaneous output 1 (OUT1) ON count monitor value

Note: The monitor value is only displayed. It cannot be set.

MODE

ōn 2L
0

Instantaneous output 2 (OUT2) ON count monitor value

Note: The monitor value is only displayed. It cannot be set.

H5CX-A□-N/-L□-N Twin Timer

Explanation of Functions

Operating Procedures for Twin Timer Function

Items marked with stars (★) can be set using the DIP switch.

OFF Time Range (OFF TIME RANGE)★

Set the time range for the OFF time in the range 0.000 s to 9,999 h. Only settings of type --.- s (99.99 s), ---.- s (999.9 s), ---- s (9,999 s), and -- min -- s (99 min 59 s) can be made with the DIP switch. Use the operation keys if another type of setting is required.

ON Time Range (ON TIME RANGE)★

Set the time range for the ON time in the range 0.001 s to 9,999 h. Only settings of type --.- s (99.99 s), ---.- s (999.9 s), ---- s (9,999 s), and -- min -- s (99 min 59 s) can be made with the DIP switch. Use the operation keys if another type of setting is required.

Timer Mode (TIMER MODE)★

Set either the elapsed time (UP) or remaining time (DOWN) mode. In UP mode, the elapsed time is displayed, and in DOWN mode, the remaining time is displayed.

ON/OFF Start Mode (ON/OFF START MODE)★

Set the output mode. Set either flicker OFF start or flicker ON start. (For details on output mode operation, refer to "Timing Charts" on page 29.)

Input Signal Width (INPUT SIGNAL WIDTH)★

Set the minimum signal input width (20 ms or 1 ms) for signal, reset, and gate inputs. The same setting is used for all external inputs (signal, reset, and gate inputs). If contacts are used for the input signal, set the input signal width to 20 ms. Processing to eliminate chattering is performed for this setting.

NPN/PNP Input Mode (NPN/PNP INPUT MODE)

Select either NPN input (no-voltage input) or PNP input (voltage input) as the input format. Set an NPN input when using a 2-wire sensor. The same setting is used for all external inputs. For details on input connections, refer to "Input Connections" on page 9.

Display Color (DISPLAY COLOR)

(Terminal black model: H5CX-A□ only)

Set the color used for the present value.

	Output OFF	Output ON
Red	Red (fixed)	
Green	Green (fixed)	
Orange	Orange (fixed)	
Red-Off	Red	Green
Green-Off	Green	Red
Red-Orange	Red	Orange
Orange-Red	Orange	Red
Green-Orange	Green	Orange
Orange-Green	Orange	Green

Key Protect Level (KEY PROTECT LEVEL)

Set the key protect level. Refer to "Key Protect Level" on page 32.

Operation in Run Mode

Operating Procedures for Twin Timer Function

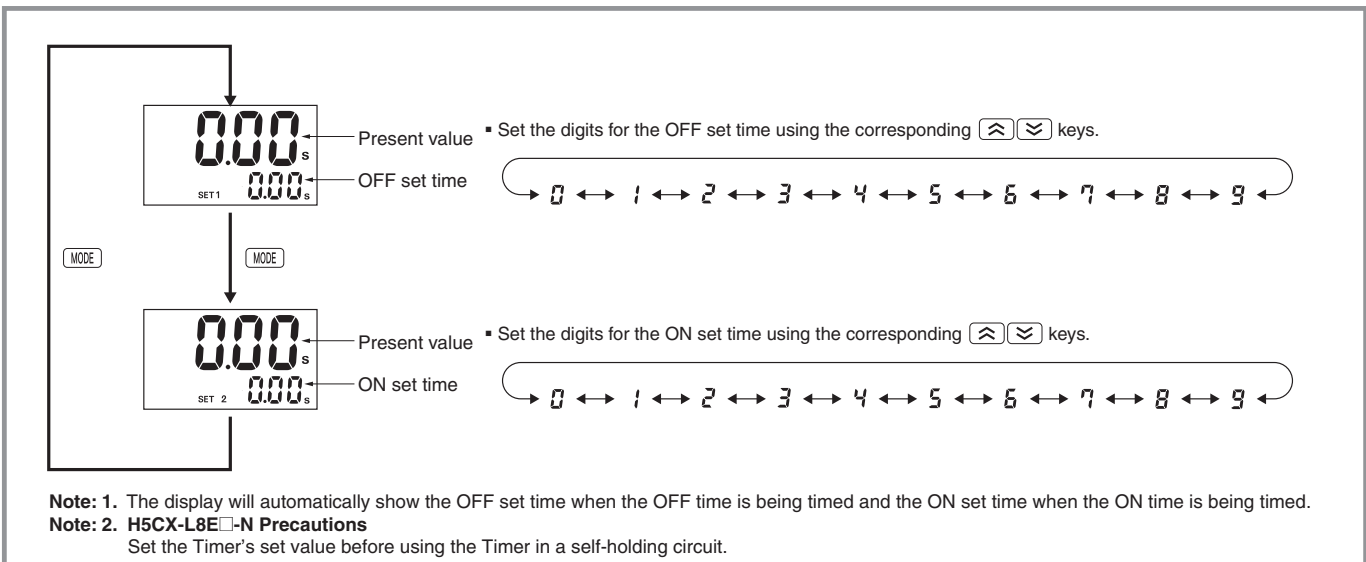

Present Value and OFF Set Time

The present value is displayed in the main display and the OFF set time is displayed in the sub-display. Set the OFF time.

Present Value and ON Set Time

The present value is displayed in the main display and the ON set time is displayed in the sub-display. Set the ON time.

Timing Charts

Operating Procedures for Twin Timer Function

Models without Instantaneous Contact Outputs

The gate input is not included in the H5CX-L8□ models.

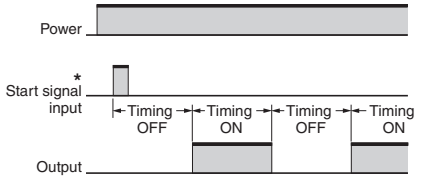
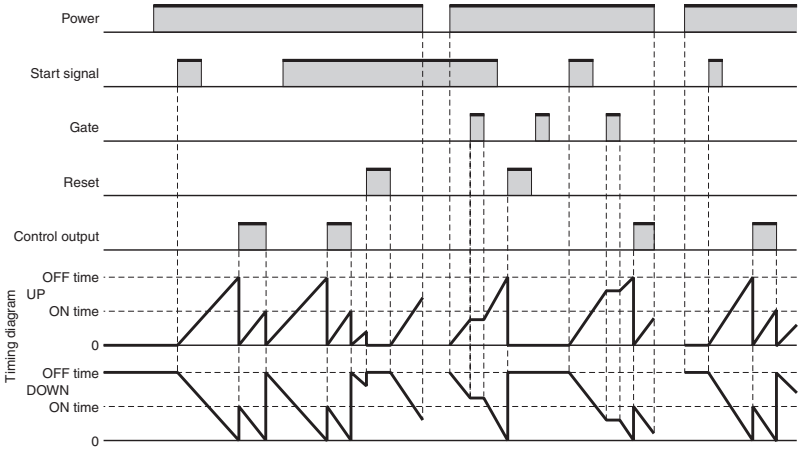
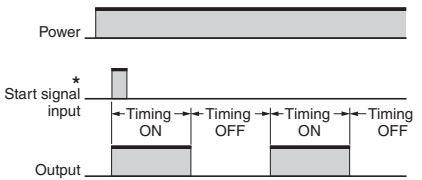
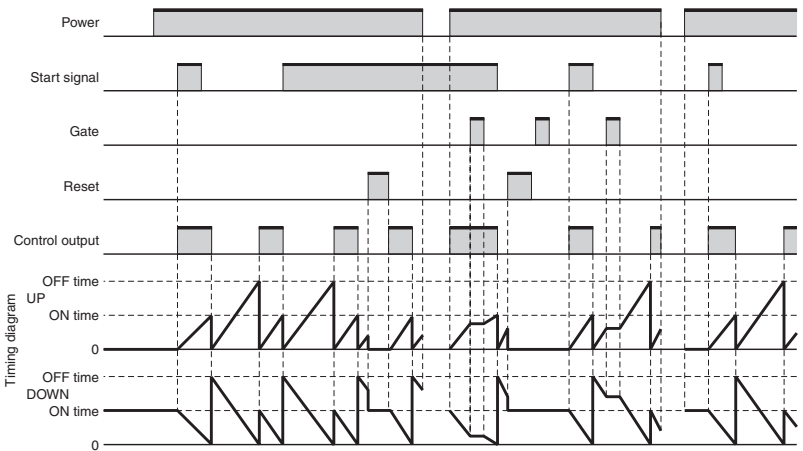
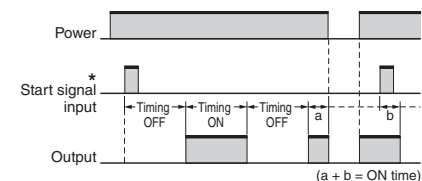
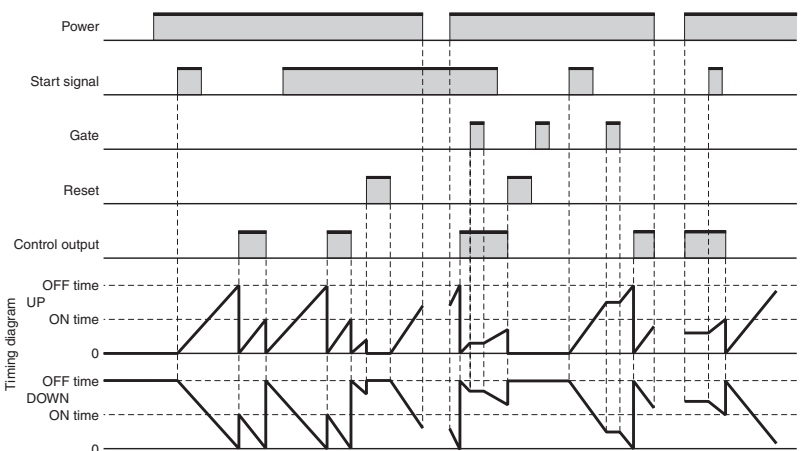
Mode toff: Flicker OFF start 1 (Timer resets when power comes ON.)	
Basic operation	Detailed operation
 <p>* Start signal input is disabled during timing.</p> <p>Timing starts when the start signal goes ON. The status of the control output is reversed when time is up (OFF at start). While the start signal is ON, the timer starts when the power comes ON or when the reset input goes OFF.</p> <p>Note: Normal output operation will not be possible if the set time is too short. Set the value to at least 100 ms (contact output type).</p>	
Mode ton: Flicker OFF start 1 (Timer resets when power comes ON.)	
Basic operation	Detailed operation
 <p>* Start signal input is disabled during timing.</p> <p>Timing starts when the start signal goes ON. The status of the control output is reversed when time is up (ON at start). While the start signal is ON, the timer starts when the power comes ON or when the reset input goes OFF.</p> <p>Note: Normal output operation will not be possible if the set time is too short. Set the value to at least 100 ms (contact output type).</p>	
Mode toff-1: Flicker OFF start 2 (Timer does not reset when power comes ON.)	
Basic operation	Detailed operation
 <p>* Start signal input is disabled during timing.</p> <p>Timing starts when the start signal goes ON. The status of the control output is reversed when time is up (OFF at start). While the start signal is ON, the timer starts when the power comes ON or when the reset input goes OFF.</p> <p>Note: Normal output operation will not be possible if the set time is too short. Set the value to at least 100 ms (contact output type).</p>	

H5CX-A□-N/-L□-N Twin Timer

Mode ton-1: Flicker ON start 2 (Timer does not reset when power comes ON.)

Basic operation

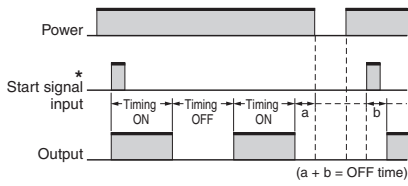

* Start signal input is disabled during timing.

Timing starts when the start signal goes ON.
The status of the control output is reversed when time is up (ON at start).
While the start signal is ON, the timer starts when the power comes ON or when the reset input goes OFF.

Note: Normal output operation will not be possible if the set time is too short.
Set the value to at least 100 ms (contact output type).

Detailed operation

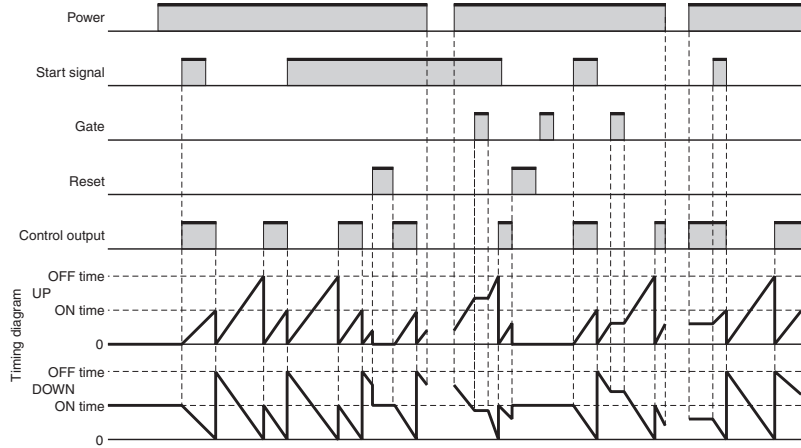

Models with Instantaneous Contact Outputs

Mode toff: Flicker OFF start 1 (Timer resets when power comes ON.)

Basic operation

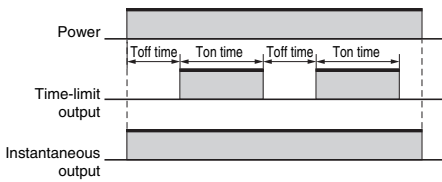

The Timer starts when the power comes ON or when the reset input goes OFF.

Note: Normal output operation will not be possible if the set time is too short.
Set the ON time and OFF time to at least 100 ms.

Detailed operation

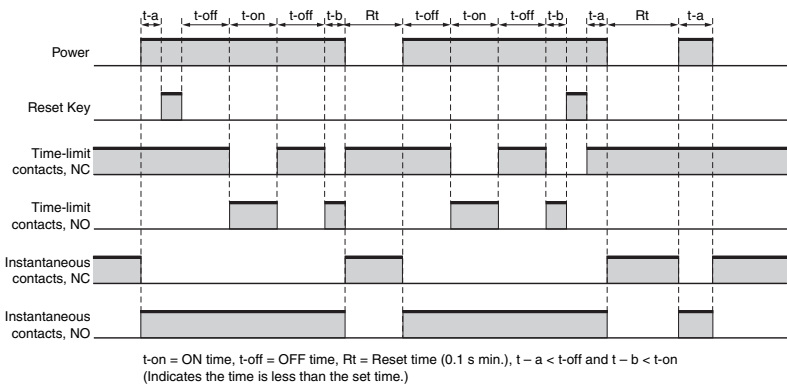

Mode ton: Flicker ON start 1 (Timer resets when power comes ON.)

Basic operation

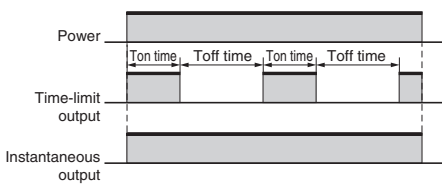

The Timer starts when the power comes ON or when the reset input goes OFF.

Note: Normal output operation will not be possible if the set time is too short.
Set the ON time and OFF time to at least 100 ms.

Detailed operation

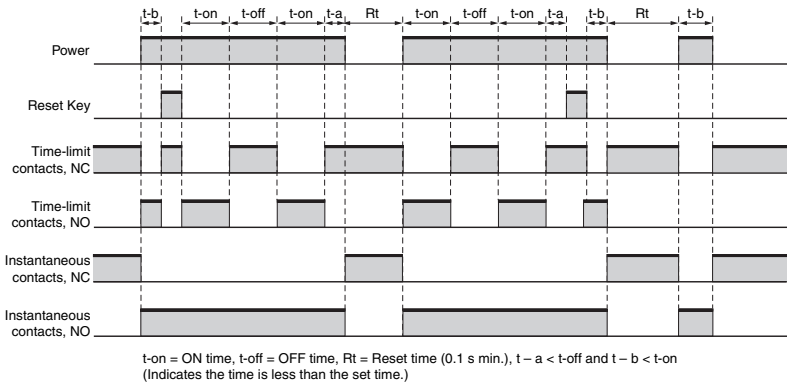

Note: H5CX-L8E□-N Precautions

Set the Timer's set value before using the Timer in a self-holding circuit.

Timer/Twin Timer Selection Mode (Function Selection)

Select whether the H5CX is used as a timer or a twin timer in timer/twin timer selection mode.

The H5CX is also equipped with a DIP switch monitor function, a convenient function that enables the settings of the DIP switch pins to be confirmed using the front display.

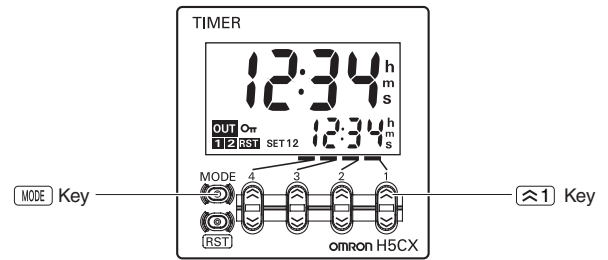
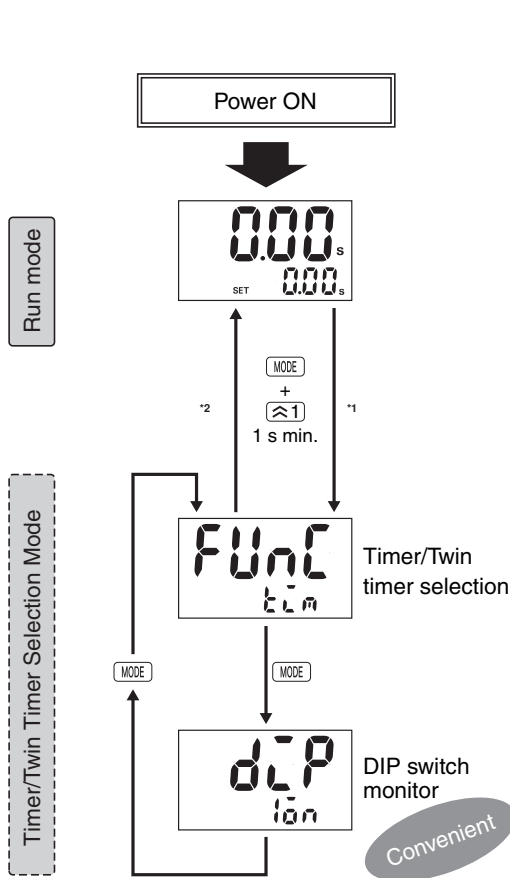

Caution

To change the mode to timer/twin timer selection mode, hold down the ≈ 1 key for 1 s min. with the ≈ 2 key held down. The ≈ 1 key must be pressed before the key. If the key is pressed first, the mode will not change.

Select either t/m timer operation or t/w twin timer operation using the ≈ 2 (≈ 3) keys.

Note: The H5CX is factory-set for timer operation.

Confirm the status of DIP switch pins 1 to 8 using the ≈ 2 (≈ 3) keys.

Note: 1. This display is not supported with H5CX-L8□-N.

2. This display is only possible when DIP switch pin 1 (DIP switch settings enable/disable) is set to ON (enable).

Example

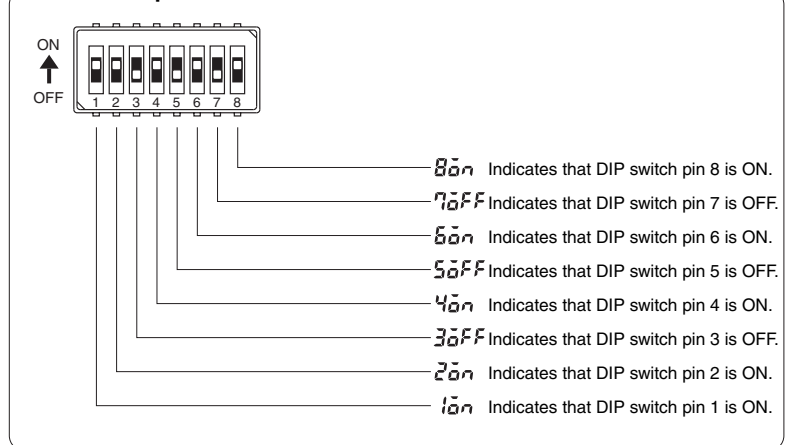

*1. When the mode is changed to timer/twin timer selection mode, the present value is reset and output turns OFF. Timing operation is not performed in timer/twin timer selection mode.

*2. Setting changes made in timer/twin timer selection mode are enabled when the mode is changed to run mode. If settings are changed, the H5CX is automatically reset (present value initialized, output turned OFF).

Key Protect Level

When the key-protect switch is set to ON, it is possible to prevent setting errors by prohibiting the use of certain operation keys by specifying the key protect level (KP-1 to KP-7).

The key protect indicator is lit while the key-protect switch is set to ON.

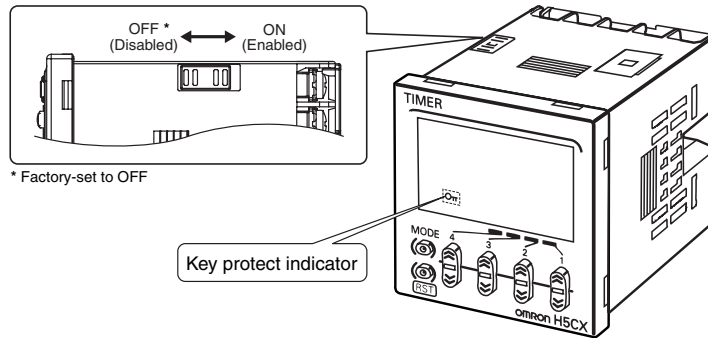

Level	Meaning	Details			
		Changing mode*	Switching display during operation	Reset Key	Up/down key
KP-1 (default setting)		Invalid	Valid	Valid	Valid
KP-2		Invalid	Valid	Invalid	Valid
KP-3		Invalid	Valid	Valid	Invalid
KP-4		Invalid	Valid	Invalid	Invalid
KP-5		Invalid	Invalid	Invalid	Invalid
KP-6		Invalid	Invalid	Valid	Valid
KP-7		Invalid	Invalid	Invalid	Valid

* Changing mode to Timer/Twin Timer Selection Mode or Function Setting Mode.

Self-diagnostic Function

The following displays will appear if an error occurs.

Main display	Sub-display	Error	Output status	Correction method	Set value after reset
E1	Not lit	CPU	OFF	Either press the reset key or reset the power supply.	No change
E2	Not lit	Memory error (RAM)	OFF	Reset the power supply.	No change
E2	Sum	Memory error EEPROM *1	OFF	Reset Key	Factory setting
E3 *2	No change	Output ON count alarm set value exceeded	No change	Reset Key	No change

*1. This includes times when the life of the EEPROM has expired.

*2. The normal display and E3 will appear alternately.

When the Reset Key is pressed, E3 will no longer be displayed even if the alarm set value is exceeded. (Monitoring is possible, however, because the Timer will continue without clearing the output ON count.)

Digital Timer H5CX-BWSD-N



- H5CX Digital Timers with 6-digit Display, 2-stage Setting, and Forecast Output (DIN 48 x 48-mm)
- Times the daily operating hours of machinery and tools, predicting and notifying when maintenance is required.
- Easy-to-read backlit negative LCD with 6 digits (displays to 99999.9 h).
- The 2-stage settings and forecast output are ideal for maintenance applications.



For the most recent information on models that have been certified for safety standards, refer to your OMRON website.

Specifications

Ratings

Classification		Digital Timer with 6-digit display, 2-stage setting, and forecast output
Ratings	Power supply voltage	12 to 24 VDC
	Operating voltage fluctuation range	90% to 110% rated supply voltage
	Power consumption	Approx. 2.3 W *1
Mounting method		Flush mounting
External connections		Screw terminals
Degree of protection		IEC IP66, UL508 Type 4X (indoors) for panel front surface only and only when Y92S-29 Waterproof Packing is used
Digits		6 digits
Time range		0.01 s to 9999.99 s, 1 s to 99 h 59 min 59 s, 0.1 min to 99999.9 min, 0.1 h to 99999.9 h
Timer mode		Elapsed time (Up)
Inputs	Input signals	Signal, reset, gate
	Input method	No-voltage Input ON impedance : 1 kΩ max. (Leakage current: 12 mA when 0 Ω) ON residual voltage : 3 V max. OFF impedance : 100 kΩ min. Voltage Input High (logic) level : 4.5 to 30 VDC Low (logic) level : 0 to 2 VDC (Input resistance: approx. 4.7 kΩ) No-voltage (NPN) input/voltage (PNP) input (switchable)
	Signal, reset, gate	Minimum input signal width: 1 or 20 ms (selectable, same for all input)
Reset system		Power resets (only for A mode), external and manual reset
Power reset		Minimum power-opening time: 0.5 s (except for F-1 mode)
Reset voltage		10% max. of rated supply voltage
Sensor waiting time		250 ms max. (Control output is turned OFF and no input is accepted during sensor waiting time.)
Outputs	Output modes	A, F-1
	Output type	Transistor output: NPN open collector, 100 mA at 30 VDC max. residual voltage: 1.5 VDC max. (Approx. 1 V) Leakage current: 0.1 mA max.
Display		7-segment, negative transmissive LCD; Present value: 10-mm-high characters, red Set value: 6-mm-high characters, green *2
Memory backup		EEPROM (overwrites: 100,000 times min.) that can store data for 10 years min.
Operating temperature range		-10 to 55°C (-10 to 50°C if counters are mounted side by side) (with no icing or condensation)
Storage temperature range		-25 to 70°C (with no icing or condensation)
Operating humidity range		25 to 85%
Case color		Black (N1.5)
Attachments		Waterproof packing, flush mounting adapter, unit label

*1. Inrush current will flow for a short time when the power supply is turned ON.
Inrush Current (Reference Values)

Voltage	Applied voltage	Inrush current (peak value)	Time
12 to 24 VDC	26.4 VDC	4.4 A	1.7 ms

*2. The display is lit only when the power is ON.

Characteristics

Accuracy of operating time and setting error (including temperature and voltage influences)		Power-ON start: $\pm 0.01\% \pm 50$ ms max. (See note 1.) Signal start: $\pm 0.005\% \pm 0.03$ ms max. (See note 1.) Signal start for transistor output model: $\pm 0.005\% \pm 3$ ms max. (See note 1 and 2.) If the set value is within the sensor waiting time at startup the control output of the H5CX will not turn ON until the sensor waiting time passes. Note: 1. The values are based on the set value. 2. The value is applied for a minimum pulse width of 1 ms.
Insulation resistance		100 M Ω min. (at 500 VDC) between current-carrying terminal and exposed non-current-carrying metal parts
Dielectric strength		2,000 VAC, 50/60 Hz for 1 min between current-carrying metal parts and non-current-carrying metal parts 1,000 VAC, 50/60 Hz for 1 min between control output, power supply, and input circuit
Impulse withstand voltage		1.0 kV (between power terminals) 1.5 kV (between current-carrying terminal and exposed non-current-carrying metal parts)
Noise immunity		± 480 V (between power terminals) and ± 600 V (between input terminals), square-wave noise by noise simulator (pulse width: 100 ns/1 μ s, 1-ns rise)
Static immunity		Destruction: 15 kV Malfunction: 8 kV
Vibration resistance	Destruction	10 to 55 Hz with 0.75-mm single amplitude in three directions for 2 h each
	Malfunction	10 to 55 Hz with 0.35-mm single amplitude in three directions for 10 min each
Shock resistance	Destruction	300 m/s ² in three directions, three cycles
	Malfunction	100m/s ² in three directions, three cycles
Weight		Approx. 105 g (Timer only)

Applicable Standards

Approved safety standards	UL508/Listing, CSA C22.2 No. 14, conforms to EN 61812-1 (pollution degree 2/overvoltage category III) Conforms to VDE0106/P100 (finger protection).	
EMC	(EMI) Emission Enclosure: (EMS) Immunity ESD: Immunity RF-interference: Immunity Burst: Immunity Surge: Immunity Conducted Disturbance: Immunity Voltage Dip/Interruption:	EN61812-1 EN55011 Group 1 class A EN61812-1 IEC61000-4-2 IEC61000-4-3 IEC61000-4-4 IEC61000-4-5 IEC61000-4-6 IEC61000-4-11

I/O Functions

Inputs	Start signal		Starts timing.
	Reset		<ul style="list-style-type: none"> Resets present value. (The present value returns to 0.) Timing stops and control output turns OFF while reset input is ON. Reset indicator is lit while reset input is ON.
	Gate		Inhibits timer operation.
Outputs	Forecast value setting	Control output (OUT2)	Turns ON when the present value reaches the set value.
		Forecast output (OUT1)	Turns ON when the present value reaches the forecast value.
	Absolute value setting	Control output 2 (OUT2)	Turns ON when the present value reaches set value 2.
		Control output 1 (OUT1)	Turns ON when the present value reaches set value 1.

Response Delay Time When Resetting (Transistor Output)

The following table shows the delay from when the reset signal is input until the output is turned OFF.
(Reference value)

Minimum reset signal width	Output delay time
1 ms	0.8 to 1.2 ms
20 ms	15 to 25 ms

Connections

Block Diagram

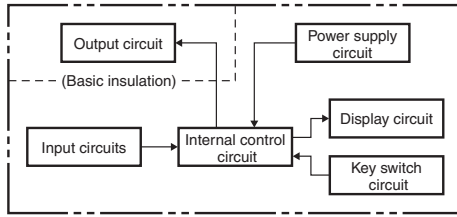

Terminal Arrangement

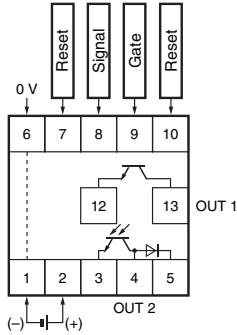

- Note:**
1. The power supply and input circuit are not isolated.
 2. Terminals 1 and 6 are connected internally.
 3. Terminals 7 and 10 have the same reset function. The same function will be performed whichever terminal is connected. Terminals 7 and 10 are not connected internally, however, so do not use them for cross-over wiring.

Input Circuits

Signal, Reset, and Gate Input

No-voltage Inputs (NPN Inputs)

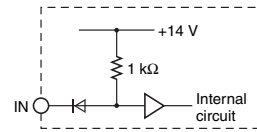

Voltage Inputs (PNP Inputs)

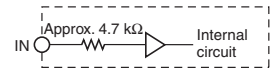

Transistor Output

- The transistor output of the H5CX is insulated from the internal circuitry by a photocoupler, so the transistor output can be used as both NPN and PNP output.
- The diode connected to the collector of the output transistor is used to absorb inverted voltage that is generated when an inductive load is connected to the H5CX.

NPN Output

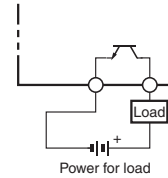

PNP Output

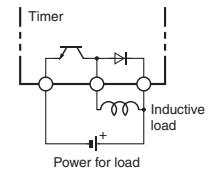
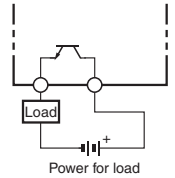

Input Connections

The inputs of the H5CX-B are no-voltage (short-circuit or open) inputs or voltage inputs.

No-voltage Inputs (NPN Inputs)

Open Collector

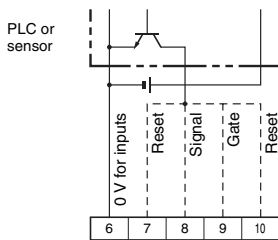

Note: Operate with transistor ON

Voltage Output

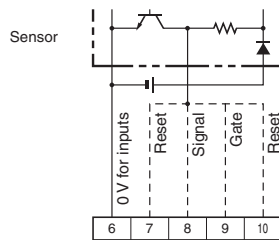

Note: Operate with transistor ON

Contact Input

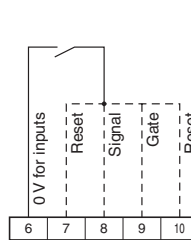

Note: Operate with relay ON

DC Two-wire Sensor

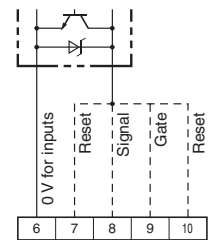

Note: Operate with transistor ON

No-voltage Input Signal Levels

No-contact input	Short-circuit level (Transistor ON)
	<ul style="list-style-type: none"> • Residual voltage: 3 V max. • Impedance when ON: 1 kΩ max. (The leakage current is approx. 12 mA when the impedance is 0 Ω.)
Contact input	Open level (Transistor OFF)
	<ul style="list-style-type: none"> • Impedance when OFF: 100 kΩ min.
Use contacts which can adequately switch 5 mA at 10 V	

Applicable Two-wire Sensor

- Leakage current: 1.5 mA max.
- Switching capacity: 5 mA min.
- Residual voltage: 3.0 VDC max.
- Operating voltage: 10 VDC

Voltage Inputs (PNP Inputs)

No-contact Input (NPN Transistor)

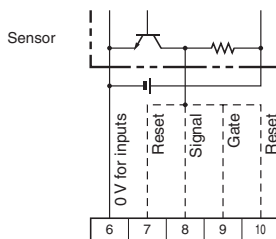

Note: Operate with transistor OFF

No-contact Input (PNP Transistor)

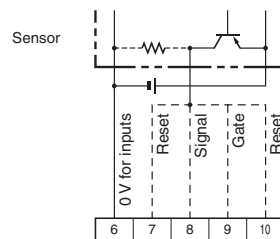

Note: Operate with transistor ON

Contact Input

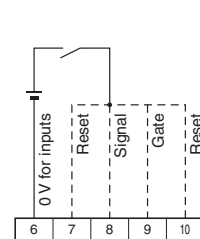

Note: Operate with relay ON

Voltage Input Signal Levels

High level (Input ON): 4.5 to 30 VDC
Low level (Input OFF): 0 to 2 VDC

- Note:**
1. The DC voltage must be 30 VDC max.
 2. Input resistance: Approx. 4.7 kΩ

H5CX-BWSD-N

Nomenclature

Display Section

- 1. Key Protection Indicator** (orange)
Lit when the reset input or Reset Key is ON.
- 2. Control Output Indicator** (orange)
Forecast value setting
Forecast output ON: OUT 1 is lit.
Control output ON: OUT 2 is lit.
Absolute value setting
Control output 1 ON: OUT 1 is lit.
Control output 2 ON: OUT 2 is lit.

- 3. Reset Indicator** (orange)
Lit when the reset input or Reset Key is ON.

- 4. Present Value Display** (red)
Character height: 10 mm
If the time range is 0.0 min or 0.0 h, the decimal point flashes to indicate timing operation.

- 5. Time Unit Indicators** (green)

- 6. Set Value** (green)
Character height: 6 mm

- 7. Set Value 1, 2 Indicator** (green)

Character Size for Present Value Display	Character Size for Set Value Display
--	--

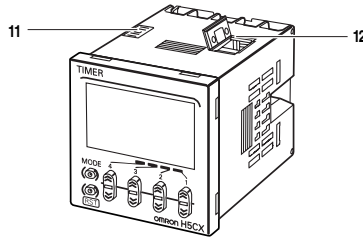
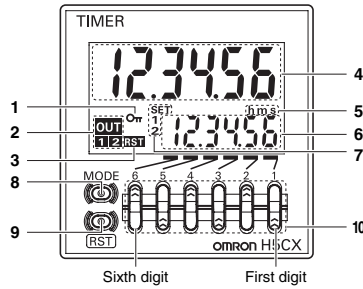
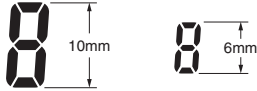

Operation Key

- 8. Mode Key**
(Changes modes and setting items)
- 9. Reset Key**
Resets present value and output.
- 10. Up Keys 1 to 6**

Switches

- 11. Key-protect Switch**

(Default setting) OFF (Disabled) ↔ ON (Enabled)

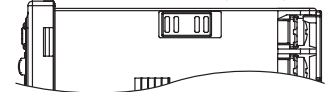

- 12. DIP Switch**

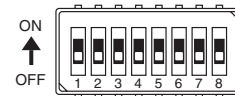

Key Protect Level

When the Key-protect Switch is ON, key operations are prohibited according to the settings for DIP switch pins 6 to 8, thus preventing setting errors.

The Key-protect Switch can be turned ON and OFF while the power is ON.

The Key Protection Indicator is lit orange when the Key-protect Switch is ON.

If the key protect switch is ON, you will not be able to switch to Function Setting Mode.

Dimensions

(unit: mm)

Digital Timers

Digital Timers

H5CX-BWSD-N (Flush Mounting Models)

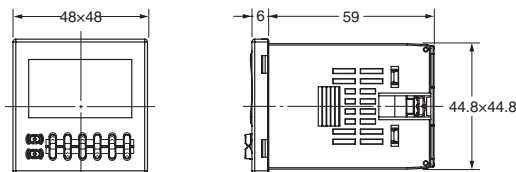
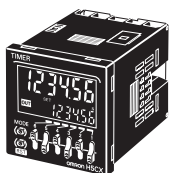

Note: M3.5 terminal screw (effective length: 6 mm)

Panel Cutouts

Panel cutouts areas shown below. (according to DIN43700)

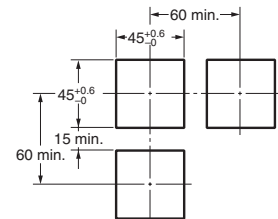

- The mounting panel thickness should be 1 to 5 mm.
- To allow easier operation, it is recommended that Adapters be mounted so that the gap between sides with hooks is at least 15 mm (i.e., with the panel cutouts separated by at least 60 mm).
- It is possible to mount Timers side by side, but only in the direction without the hooks. However, if Timers are mounted side by side, water resistance will be lost.

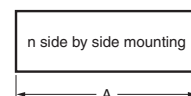

$$A = (48n - 2.5)_{-0}^{+1}$$

With Y92A-48F1 attached.

$$A = (48n - 2.5 + (n - 1) \times 4)_{-0}^{+1}$$

With Y92A-48 attached.

$$A = (51n - 5.5)_{-0}^{+1}$$

Dimensions with Flush Mounting Adapter

H5CX-BWSD-N (Provided with Adapter and Waterproof Packing)

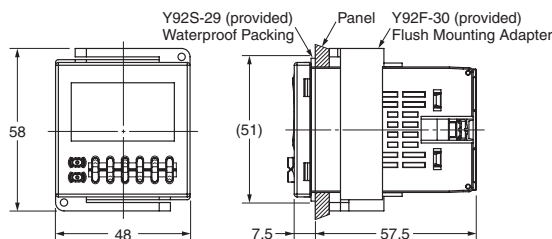
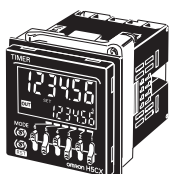

Accessories (Order Separately)

Refer to page 12 for details.

Operating Procedures

DIP Switch Settings

All functions are set using the DIP switch.

	Item	OFF	ON
1	Time range	Refer to the table on the right.	
2			
3	Output modes	F-1 mode	A mode
4	Input signal width	20 ms	1 ms
5	NPN/PNP input mode	NPN (no-voltage)	PNP (voltage)
6	Reset Key protection	Disabled	Enabled
7	Up Key protection	Disabled	Enabled
8	Mode Key protection	Disabled	Enabled

Pin 1	Pin 2	Time range
OFF	OFF	0.1 h to 99999.9 h
ON	OFF	0.01 s to 9999.99 s
OFF	ON	0 h 00 min 01 s to 99 h 59 min 59 s
ON	ON	0.1 min to 99999.9 min

- Note:**
1. All the pins are factory-set to OFF.
 2. DIP switch settings are effective when the power is turned ON again. (Set the DIP switch before installation and power-up.)

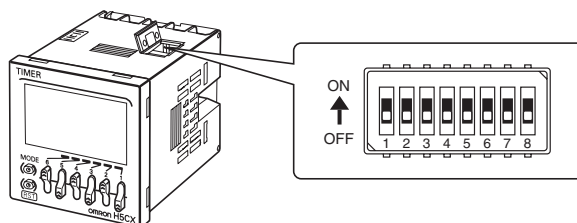

Operation in Run Mode

Set the digits for the set values using the corresponding Key.

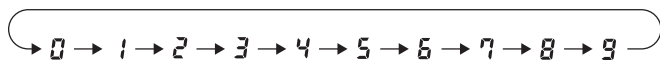

Forecast Value Setting

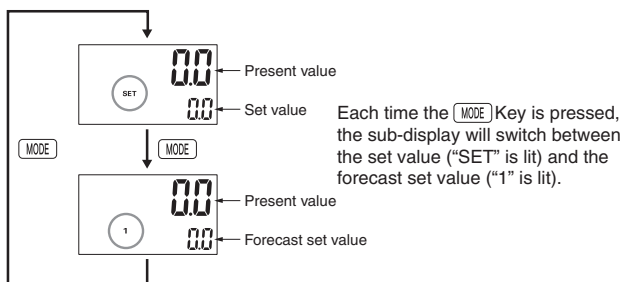

Absolute Value Setting

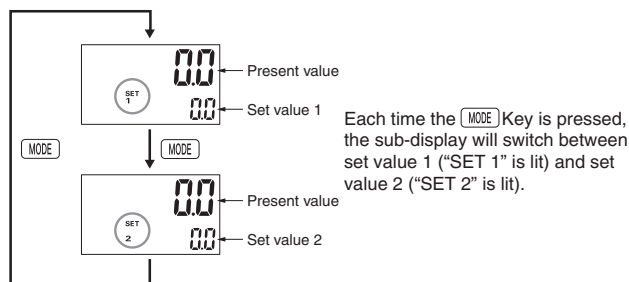

Operation in Function Setting Mode

Settings that cannot be performed with the DIP switch are performed with the operation keys.

- Change to Function Setting Mode.

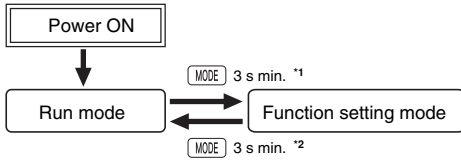

- *1. If the mode is switched to the function setting mode during operation, operation will continue.
- *2. Changes made to settings in function setting mode are enabled for the first time when the mode is changed to run mode. Also, when settings are changed, the timer is reset (time initialized and output turned OFF).

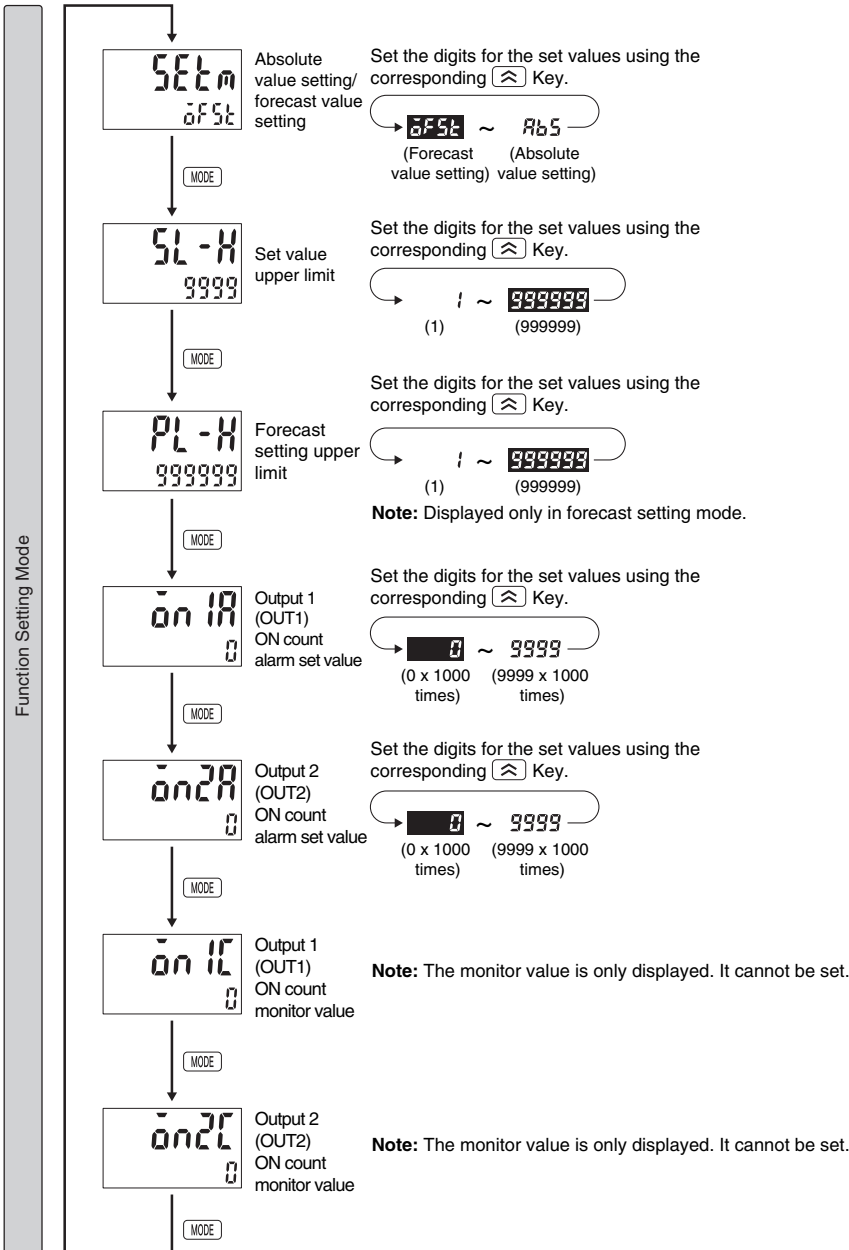

Explanation of Functions

Absolute value setting/forecast value setting (SEEM)

Set value 1 can be set as the forecast value setting (ãF5t) or the absolute value setting (Rb5).

Forecast Value Setting

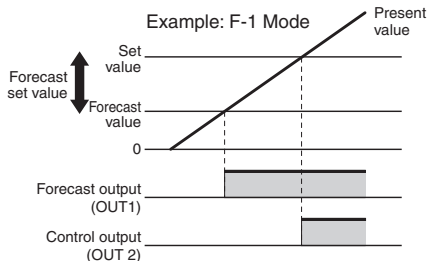

- OUT1 (forecast output) turns ON when the present value reaches the forecast value.
Forecast value = Set value - Forecast set value
Note: The forecast set value is used to set the deviation for the set value.
- OUT2 (control output) turns ON when the present value reaches the set value.
- If the forecast set value ≥ set value, OUT1 (forecast output) will turn ON as soon as timing starts.

Self-diagnostic Function

The following displays will appear if an error occurs.

Main display	Sub-display	Error	Output status	Correction method	Set value after reset
E1	Not lit	CPU	OFF	Either press the Reset Key or reset the power supply.	No change
E2	Not lit	Memory error (RAM)	OFF	Reset the power supply.	No change
E2	Sum	Memory error EEPROM *1	OFF	Reset Key.	Factory setting
E3 *2	No change	Output ON count alarm set value exceeded	No change	Reset Key	No change

*1. This includes times when the life of the EEPROM has expired.

*2. The normal display and E3 will appear alternately.

When the Reset Key is pressed, E3 will no longer be displayed even if the alarm set value is exceeded. (Monitoring is possible, however, because the Timer will continue without clearing the output ON count.)

Absolute Value Setting

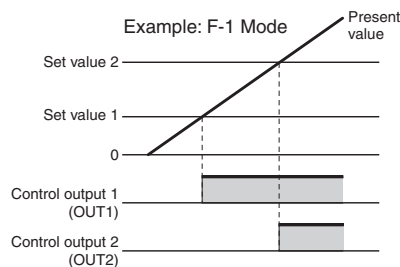

- OUT1 (control output 1) turns ON when the present value reaches set value 1.
- OUT2 (control output 2) turns ON when the present value reaches set value 2.

Refer to pages 18 and 28 for information on other functions.

Timing Charts

Mode A: Signal ON delay (Timer resets when power comes ON.)

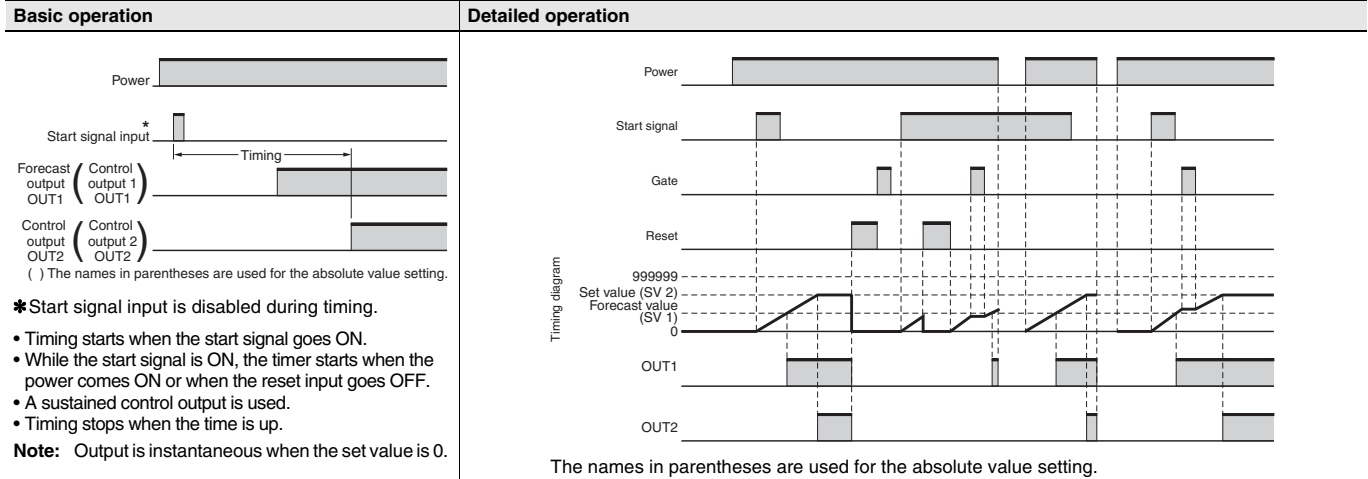

Mode F-1: Cumulative (Timer does not reset when power comes ON.)

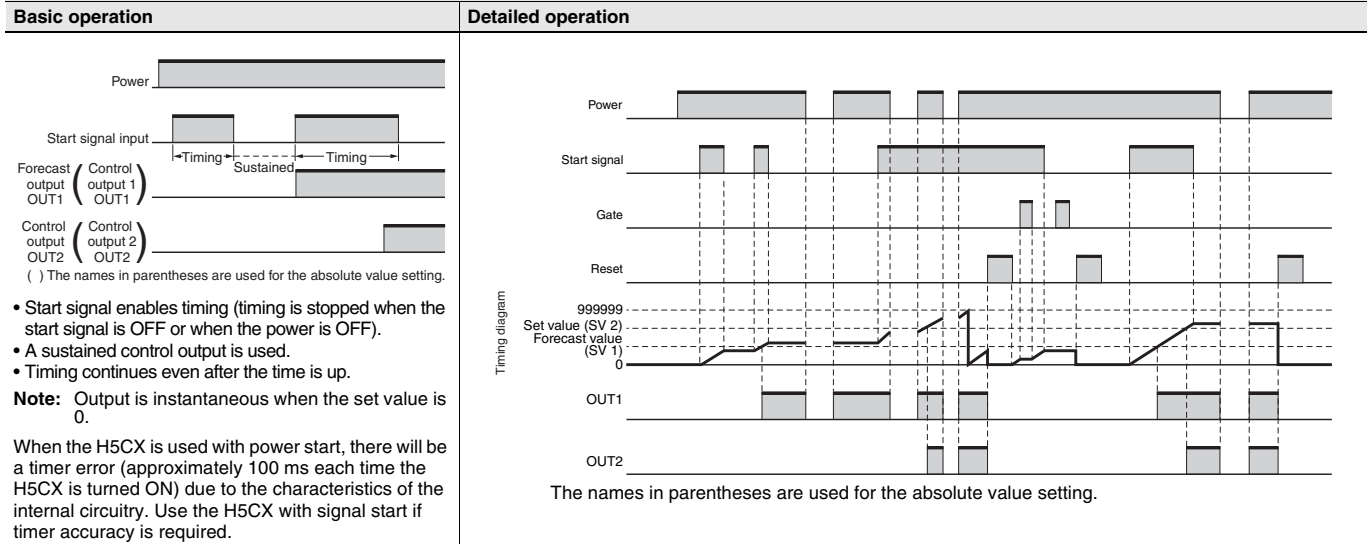

- Note:**
1. The forecast value = set value - forecast set value
 2. The forecast set value is used to set the deviation for the set value.

Safety Precautions for All H5CX Series (Common)

CAUTION

Do not allow pieces of metal, wire clippings, or fine metallic shavings or fillings from installation to enter the product. Doing so may occasionally result in electric shock, fire, or malfunction.



Minor injury due to explosion may occasionally occur. Do not use the Timer where subject to flammable or explosive gas.



Fire may occasionally occur. Tighten the terminal screws to the rated torque.
H5CX terminals: 6.55 to 7.97 lb-in (0.74 to 0.90 N·m)
P2CF Socket terminals: 4.4 lb-in (0.5 N·m)



Minor injury due to electric shock may occasionally occur. Do not touch any of the terminals while power is being supplied. Be sure to mount the terminal cover after wiring.



The life expectancy of the output relay varies considerably according to its usage. Use the output relay within its rated load and electrical life expectancy. If the output relay is used beyond its life expectancy, its contacts may become fused or there may be a risk of fire. Also, be sure that the load current does not exceed the rated load current and when using a heater, be sure to use a thermal switch in the load circuit.



Minor electric shock, fire, or malfunction may occasionally occur. Do not disassemble, modify, or repair the Timer or touch internal components.



Precautions for Safe Use

- The panel surface of the H5CX is water-resistant (conforming to NEMA4, IP66, UL Type 4X (Indoor Use Only). To protect the internal circuits from water penetration through the space between the H5CX and operating panel, waterproof packing is included. Attach the Y92F-30 Adapter with sufficient pressure with the reinforcing screws so that water does not penetrate the panel.

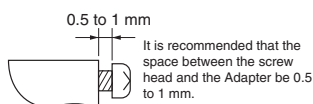

- When mounting the Timer to a panel, tighten the two mounting screws alternately, a little at a time, so as to keep them at an equal tightness. If the panel screws are tightened unequally, water may enter the panel.
- Store the Timer at the specified temperature. If the Time has been stored at a temperature of less than -10°C, allow the Time to stand at room temperature for at least 3 hours before use.
- Mounting the Timer side-by-side may reduce the life expectancies of internal components.
- Use the Timer within the specified ranges for the ambient operating temperature and humidity.
- Do not use in the following locations:
 - Locations subject to sudden or extreme changes in temperature.
 - Locations where high humidity may result in condensation.
- Do not use the Timer outside of the rated ranges for vibration, shock, water exposure, and oil exposure.
- Do not use this Timer in dusty environments, in locations where corrosive gasses are present, or in locations subject to direct sunlight.
- Install the Timer well away from any sources of static electricity, such as pipes transporting molding materials, powders, or liquids.
- Internal elements may be destroyed if a voltage outside the rated voltage range is applied.

- Be sure that polarity is correct when wiring the terminals.
- Separate the Timer from sources of noise, such as devices with input signals from power lines carrying noise, and wiring for I/O signals.
- Do not connect more than two crimp terminals to the same terminal.
- Up to two wires of the same size and type can be inserted into a single terminals.
- Use the specified wires for wiring.
Applicable Wires: AWG 18 to AWG 22, solid or twisted, copper.
Wiring stripping length: 5 to 6 mm (recommended)
- Install a switch or circuit breaker that allows the operator to immediately turn OFF the power, and label it to clearly indicate its function.
- When the Timer is operated with no-voltage input (NPN input), approximately 14 V is output from the input terminals. Use a sensor that contains a diode.

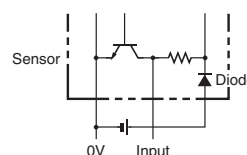

- Use a switch, relay, or other contact so that the rated power supply voltage will be reached within 0.1 seconds. If the power supply voltage is not reached quickly enough, the Timer may malfunction or outputs may be unstable.
- Use a switch, relay, or other contact to turn the power supply OFF instantaneously. Outputs may malfunction and memory errors may occur if the power supply voltage is decreased gradually.
- H5CX-A□-N/-L□-N:
When changing the set value during a timing operation, the output will turn ON if the set value is changed as follows because of the use of a constant read-in system:
Elapsed time (UP) mode: Present value \geq Set value
Remaining time (DOWN) mode: Elapsed time \geq Set value (The present value is set to 0.)
When in the remaining time mode, the amount the set value is changed is added to or subtracted from the present value.
Operation with a set value of 0 will vary with the output mode. Refer to the timing charts on **page 20**.
- H5CX-B□-N:
When changing the set value during a timing operation, the output will turn ON if the set value is changed as follows because of the use of a constant read-in system:
 - Forecast Value Setting
When the present value \geq the set value, OUT2 (control output) turns ON.
When the present value \geq the forecast value (forecast value = set value - forecast set value), OUT1 (forecast output) turns ON.
 - Absolute Value Setting
When the present value \geq set value 2, OUT2 (control output 2) turns ON.
When the present value \geq the forecast value (forecast value = set value - forecast set value), OUT1 (control output 1) turns ON.
When the set value is 0, the output turns ON the moment the signal is input. The reset operation turns OFF the output.
- Do not use organic solvents (such as paint thinners or benzene), strong alkali, or strong acids. They will damage the external finish.
- Confirm that indications are working normally, including the backlight LED, and LCD. The indicator LEDs, LCD, and resin parts may deteriorate more quickly depending on the application environment, preventing normal indications. Periodic inspection and replacement are required.
- The waterproof packing may deteriorate, shrink, or harden depending on the application environment. Periodic inspection and replacement are required.

Precautions for Correct Use

- H5CX models with a 24-VDC/12 to 24-VDC power supply use a transformer-free power supply method in which the power supply terminals are not isolated from the signal input terminals. If a non-isolating DC power supply is used, unwanted current paths may occasionally burn or destroy internal components depending on the wiring. Always check the wiring sufficiently before use.
- An inrush current of approx. 10 A will flow for a short time when the power supply is turned ON. If the capacity of the power supply is not sufficient, the Timer may not start. Be sure to use a power supply with sufficient capacity.
- Maintain voltage fluctuations in the power supply within the specified operating voltage range.
- When turning the power ON and OFF, input signal reception is possible, unstable, or impossible as shown in the diagram below.

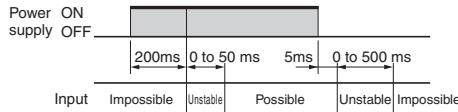

- To allow for the startup time of peripheral devices (sensors, etc.), the Timer starts timing operation between 200 to 250 ms after power is turned ON. For this reason, in operations where timing starts from power ON, the time display will actually start from 249 ms. If the set value is 249 ms or less, the time until output turns ON will be a fixed value between 200 and 250. The present value display will start from 250 ms. (Normal operation is possible for set values of 250 ms or more.) In applications where a set value of 249 ms or less is required, use start timing with signal input.
- Inrush current generated by turning ON or OFF the power supply may deteriorate contacts on the power supply circuit. Turn ON or OFF to a device with the rated current of more than 10 A.
- Make sure that all settings are appropriate for the application. Unexpected operation resulting in property damage or accidents may occur if the settings are not appropriate.
- Do not leave the Timer for long periods at a high temperature with output current in the ON state. Doing so may result in the premature deterioration of internal components (e.g., electrolytic capacitors).
- EEPROM is used as backup memory when the power is interrupted. The write life of the EEPROM is 100,000 writes. The EEPROM is written at the following times:
 - When the power supply is turned OFF
 - When switching from Timer/Twin Timer Selection Mode or Function Setting Mode to Run Mode
- Dispose of the product according to local ordinances as they apply.
- Attach the front panel when using the Timer. The tabs in the middle of each of four sides secure the front panel to the main body. To remove the panel, widen the four tabs and pull the panel toward you. To mount the panel, fit all four tabs correctly into the grooves on the main body.

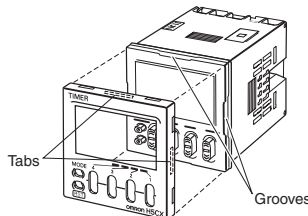

⚠ Conformance to EN/IEC Standards

- When conforming to EMC standards, refer to the information provided in this datasheet for cable selection and other conditions.
- This is a class A product. In residential areas it may cause radio interference, in which case the user may be required to take adequate measures to reduce interference.
- H5CX-A□-N/L□-N:
Basic insulation is provided between the power supply and input terminals. (No insulation is provided between the power supply and input terminals for the H5CX-□D-N.)
Basic insulation is provided between power supply and output terminals, and between input and output terminals.
- H5CX-B□-N:
No insulation is provided between the power supply and input terminals.
Basic insulation is provided between the power supply and output terminals.
- When double insulation or reinforced insulation is required, apply double insulation or reinforced insulation as defined in IEC 60664 that is suitable for the maximum operating voltage with clearances or solid insulation.
- Connect the input and output terminals to devices that do not have any exposed charged parts.

Warranty and Application Considerations

Read and Understand This Catalog

Please read and understand this catalog before purchasing the products. Please consult your OMRON representative if you have any questions or comments.

Warranty and Limitations of Liability

WARRANTY

OMRON's exclusive warranty is that the products are free from defects in materials and workmanship for a period of one year (or other period if specified) from date of sale by OMRON.

OMRON MAKES NO WARRANTY OR REPRESENTATION, EXPRESS OR IMPLIED, REGARDING NON-INFRINGEMENT, MERCHANTABILITY, OR FITNESS FOR PARTICULAR PURPOSE OF THE PRODUCTS. ANY BUYER OR USER ACKNOWLEDGES THAT THE BUYER OR USER ALONE HAS DETERMINED THAT THE PRODUCTS WILL SUITABLY MEET THE REQUIREMENTS OF THEIR INTENDED USE. OMRON DISCLAIMS ALL OTHER WARRANTIES, EXPRESS OR IMPLIED.

LIMITATIONS OF LIABILITY

OMRON SHALL NOT BE RESPONSIBLE FOR SPECIAL, INDIRECT, OR CONSEQUENTIAL DAMAGES, LOSS OF PROFITS, OR COMMERCIAL LOSS IN ANY WAY CONNECTED WITH THE PRODUCTS, WHETHER SUCH CLAIM IS BASED ON CONTRACT, WARRANTY, NEGLIGENCE, OR STRICT LIABILITY.

In no event shall the responsibility of OMRON for any act exceed the individual price of the product on which liability is asserted. IN NO EVENT SHALL OMRON BE RESPONSIBLE FOR WARRANTY, REPAIR, OR OTHER CLAIMS REGARDING THE PRODUCTS UNLESS OMRON'S ANALYSIS CONFIRMS THAT THE PRODUCTS WERE PROPERLY HANDLED, STORED, INSTALLED, AND MAINTAINED AND NOT SUBJECT TO CONTAMINATION, ABUSE, MISUSE, OR INAPPROPRIATE MODIFICATION OR REPAIR.

Application Considerations

SUITABILITY FOR USE

OMRON shall not be responsible for conformity with any standards, codes, or regulations that apply to the combination of products in the customer's application or use of the products.

Take all necessary steps to determine the suitability of the product for the systems, machines, and equipment with which it will be used.

Know and observe all prohibitions of use applicable to this product.

NEVER USE THE PRODUCTS FOR AN APPLICATION INVOLVING SERIOUS RISK TO LIFE OR PROPERTY WITHOUT ENSURING THAT THE SYSTEM AS A WHOLE HAS BEEN DESIGNED TO ADDRESS THE RISKS, AND THAT THE OMRON PRODUCTS ARE PROPERLY RATED AND INSTALLED FOR THE INTENDED USE WITHIN THE OVERALL EQUIPMENT OR SYSTEM.

Disclaimers

PERFORMANCE DATA

Performance data given in this catalog is provided as a guide for the user in determining suitability and does not constitute a warranty. It may represent the result of OMRON's test conditions, and the users must correlate it to actual application requirements. Actual performance is subject to the OMRON *Warranty and Limitations of Liability*.

CHANGE IN SPECIFICATIONS

Product specifications and accessories may be changed at any time based on improvements and other reasons. Consult with your OMRON representative at any time to confirm actual specifications of purchased product.

DIMENSIONS AND WEIGHTS

Dimensions and weights are nominal and are not to be used for manufacturing purposes, even when tolerances are shown.

ALL DIMENSIONS SHOWN ARE IN MILLIMETERS.

To convert millimeters into inches, multiply by 0.03937. To convert grams into ounces, multiply by 0.03527.

OMRON Corporation Industrial Automation Company

Tokyo, JAPAN

Contact: www.ia.omron.com

Regional Headquarters

OMRON EUROPE B.V.

Wegalaan 67-69-2132 JD Hoofddorp
The Netherlands
Tel: (31)2356-81-300/Fax: (31)2356-81-388

OMRON ELECTRONICS LLC

One Commerce Drive Schaumburg,
IL 60173-5302 U.S.A.
Tel: (1) 847-843-7900/Fax: (1) 847-843-7787

OMRON ASIA PACIFIC PTE. LTD.

No. 438A Alexandra Road # 05-05/08 (Lobby 2),
Alexandra Technopark,
Singapore 119967
Tel: (65) 6835-3011/Fax: (65) 6835-2711

OMRON (CHINA) CO., LTD.

Room 2211, Bank of China Tower,
200 Yin Cheng Zhong Road,
PuDong New Area, Shanghai, 200120, China
Tel: (86) 21-5037-2222/Fax: (86) 21-5037-2200

Authorized Distributor:

© OMRON Corporation 2009 All Rights Reserved.
In the interest of product improvement,
specifications are subject to change without notice.

CSM_5_3_0519
Cat. No. L111-E1-01

Printed in Japan
0709